



OVEN LINE

STRATOS

STRATOS MODULAR ELECTRIC OVEN
FOR PIZZA, PASTRY AND BREAD



MODULAR ELECTRIC OVENS

THE ELECTRIC MODULAR SYSTEM THAT MEETS YOUR NEEDS

Stratos originates from the idea of creating an electric oven perfectly adaptable to clients' needs. Maximum versatility, great energy efficiency and cooking perfection, make it ideal for bakeries, pastry shops and pizzerias that need high flexibility in production. Stratos also allows you to highly personalise its look. There are four versions:

- **CRYSTAL** with doors in screen-printed tempered glass

- **CLASSIC** with insulated doors in stainless steel
- **OLD STYLE** with AISI 304 steel face electro-chemically painted black and inserts in aged brass and analogical thermostats. 3 decks oven, height 18 cm.

A stainless steel proofer can be combined with the oven, which can be equipped with a humidity control kit.



Stratos Crystal



Stratos Classic

MAXIMUM EFFICIENCY HIGH RELIABILITY

Great reliability over time

Many of the design and construction features are designed to minimise the need for maintenance and to ensure high reliability in the time.

Some of these are:

- Electrical panel and connections are positioned away from the hotter spots and steam vents
- Highly durable resistors
- Safety thermostats for the protection of Decks and the steam generators in case of malfunction

Major heat insulation (160 mm)

The insulation efficiency is at the category's maximum levels thanks to the use of combined insulating materials with an average perimeter thickness of 160 mm (except model 2STL 6040).

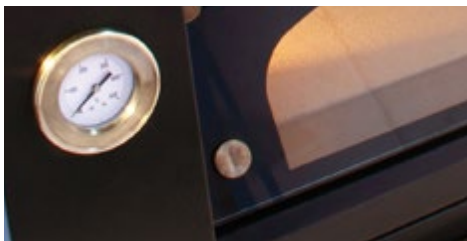

The Stratos Old Style version with aged brass inserts and analogical thermostats.



*Stratos Old Style
Mod. 2STA 4060*

WHAT ARE THE SECRETS OF GENTLE AND UNIFORM COOKING?

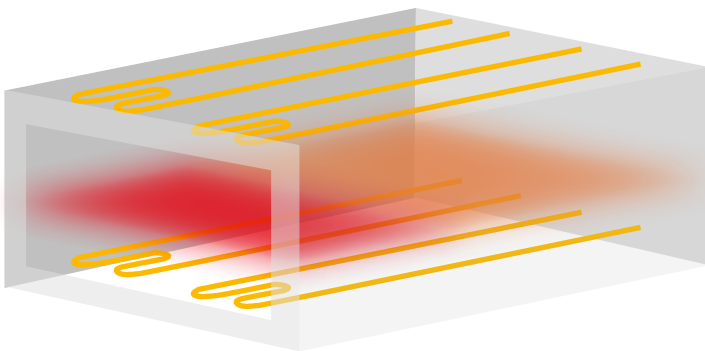

The heat generated by the resistors of a traditional electric oven.

A system that diffuses a soft and uniform heat in the Deck

In traditional ovens, resistors are often too few and too spaced out from each other. This forces them to work at very high temperatures to provide the necessary heat to the product, risking harsh and non-uniform cooking.

In Stratos the problem has been solved with a larger number of special steel armoured heating resistors, placed in close proximity. The power is therefore distributed and generates a softer, widespread and readily available heat.

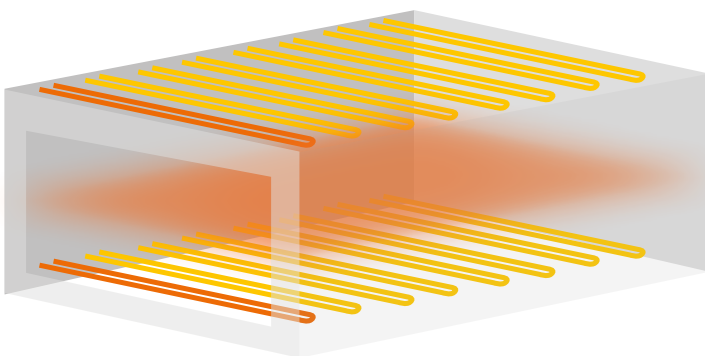

The uniform heat created by the resistors of Stratos.

Independent control of resistor in the opening (Auto Level)

In traditional electric ovens losses from the doors are usually offset merely by a simple reinforcement of front resistors that, however, does not allow the correction of any cooking non-uniformity. Stratos, on the other hand, is equipped with two electric elements for top and bottom, adjustable independently, to have a dynamic control (automatic) of the temperature through an additional probe.

Independent control of top/bottom control (Dual Level)

Stratos is equipped of an independent device to adjust the temperature of the baking chamber top and bottom (deck) with thermostats.

TRADITIONAL OVEN

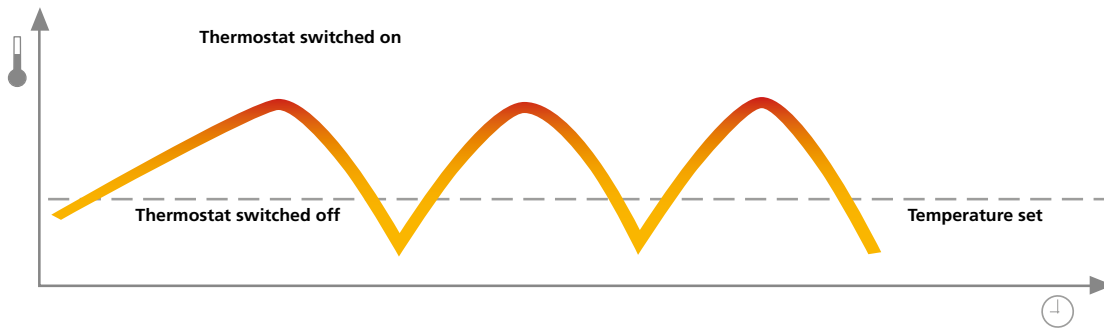

STRATOS

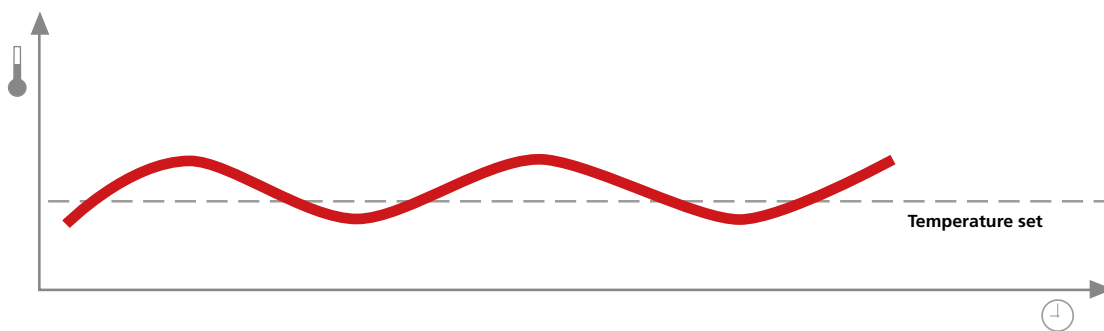

Temperature constant thanks to the heat control system

Normal temperature controls (thermostat always on or always off) lead to an inevitable heat inertia, resulting in a waste of energy and problems with cooking.

Stratos oven is provided with a heat inertia control system that makes it possible to reduce the surges and maintain the set temperature more constant.



MODULAR ELECTRIC OVENS

POLIN EXPERIENCE AT THE SERVICE OF FUNCTIONALITY

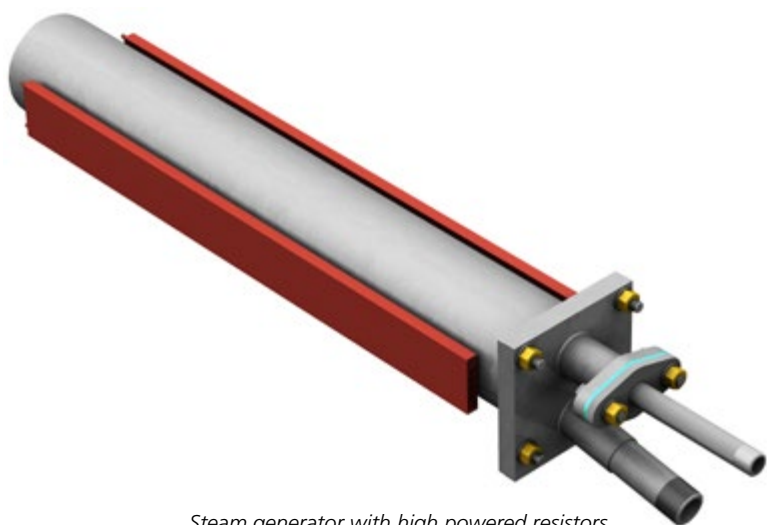

Steam generator with high powered resistors

Controllable steam in abundance

Stratos steam generator is equipped with highly powerful resistors, capable of always guaranteeing a generous amount of steam.

The steam generator (optional) has a large heating element that is placed in the back of the Deck. It has great insulation, as well as inspection fittings and heads that are made in anticorrosion materials.

Doors that make work easier

The doors of the Stratos oven have an inward opening system that avoids accidental contact typical of the tilting opening systems, during loading and unloading. In this way you avoid unpleasant burns and annoying obstructions.

The handles are functional for work and immune from overheating because placed outside the opening and made of heat insulating material.

The door can be cleaned without the need to remove the glass, avoiding risks of breakage and energy loss over time.





Four different deck baking plates

Stratos ovens can have different deck baking plates, to be adapted to different needs. There are four baking plates available:

- Embossed plate (standard): particularly suitable for light pastries on trays
- Fiber cement: ideal for pastries and bread
- Reinforced concrete: thick plates ideal for heavy products such as bread, buns and pizza mainly on baking trays
- Refractory material: an alternative plate to reinforced concrete, ideal for direct cooking of pizzas and focaccia



Embossed plate

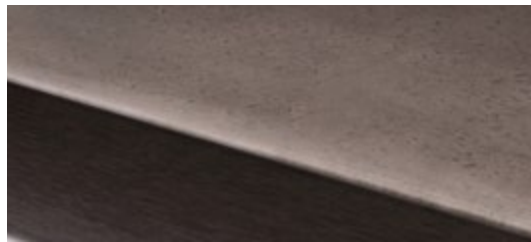

Fibro cement plate



Reinforced concrete plate

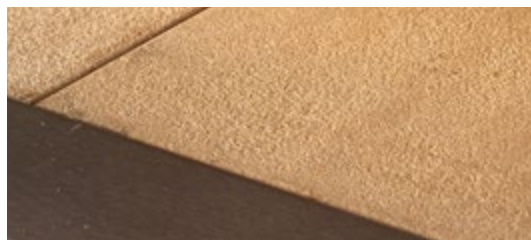

Refractory plate

MODULAR ELECTRIC OVENS

TO COOK AS YOU WISH

Stratos allows you to choose among 6 different control settings top/bottom in order to meet your specific needs.



Standard Digital keyboard



100 program Digital keyboard



Proofer digital keyboard

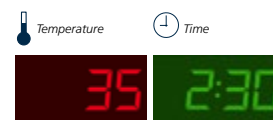

Two coloured display cell

STANDARD Digital keyboard

- Separate control of the Deck and opening (dispersion offsetting in the opening)
- Independent temperature top and bottom using a double probe (Dual Level)
- Splitter: allows you to assign different percentages of power to the top and to the bottom for an infinite variety of cooking types
- Diagnostic program with display of the alarms and data storage function, for a constant control of the oven's efficiency
- Switching on and off of steam generator with adjustable steaming time (steam generator optional)
- Timer with acoustic signal for end of cooking
- Automatic turning on and off daily or weekly
- Fine Bake Keys

100 Program Digital keyboard (optional)

- All functions of the Standard keyboard
- Manual - Automatic use setting
- 99 program memory.
Each program allows you to set:
 - 3 temperature phases for each program (to go from one temperature to another after a pre-set time).
 - The amount of steam dispensed automatically (steam generator optional).
 - Open/close valve cycle aut. vapour discharge.
 - Splitting ratio between the top and the bottom.
 - Opening power adjustment.
 - Level of energy

Card options

- Power Saver, to limit the power required for the installation of ovens with 2 to 5 Decks
- Increased power for cooking pizzas and focaccia (Super Power)
- Dynamic control of the temperature control of the opening via probe (Auto Level)
- Regulation of humidity percentage inside the proofer

Connection



RAPID CONTROL FOR PERFECT COOKING QUALITY

The digital keyboard on Stratos has Fine Bake Keys buttons, which allow you to act quickly and easily on functions that perfect the quality of cooking.

Fine Bake Keys



ENERGY LEVEL BUTTON

Lets you set an optimal amount of energy according to the type of product to be cooked.



CONTROLLED HEATING BUTTON

Regulates the heating at start-up standardising the first baking cycle with subsequent baking cycles. Also eliminates energy waste.



PAUSE BUTTON BETWEEN TWO COOKING CYCLES

Eliminates overheating of the oven bottom and reduces up to 18% energy consumption.



MODULAR ELECTRIC OVENS

YOU CAN CONFIGURE THE OVEN HOWEVER YOU WANT

1. Hood without extractor function
2. Hood with extractor fan
3. Top element
4. Hood air condenser
5. Deck 18 cm glass door
6. Deck 22 cm glass door
7. Deck 30 cm glass door
8. Steam generator*
9. Deck 18 cm insulated door
10. Deck 30 cm insulated door
11. Lower element with pull out shelf
12. Lower element
13. Pan holding box
14. Base on adjustable feet*
15. Base on wheels*
16. Ventilated final proofer*
17. Base with side panels*
18. Pan holding rack*
19. Wheel kit for base/proofer with side panels*

* OPTIONAL

Build options

- Dry air activated carbon steam condenser
- Hooks in the opening for small manual loader
- Internal coating in refractory material
- Low emission doors with mirrored glass to reduce heat loss (-15%)
- Prover humidity control kit



Stratos 2STA Crystal
Unico 4060/5



Stratos 2STL Classic
Wind 6040/5



Stratos 3STA Classic
Wind 4060/5

UPPER ELEMENTS

BAKING PLATES

LOWER ELEMENTS

STANDS

ACCESSORIES

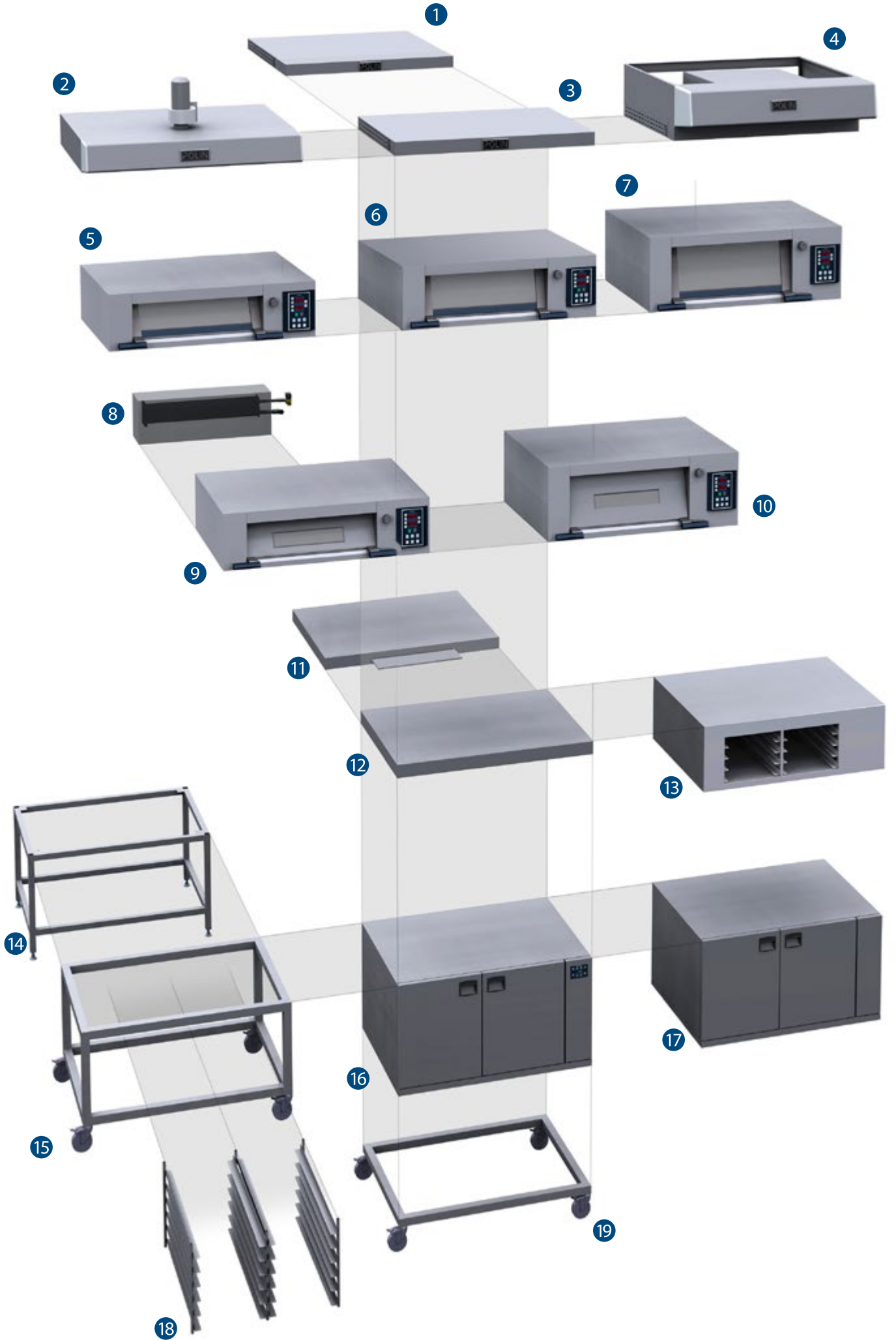

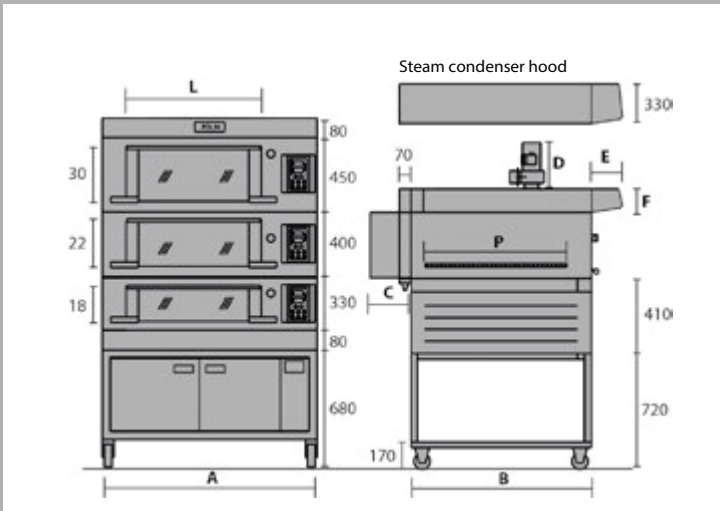

	A	B	L	P	C	D	E	F
2 STL 6040	980	1110	620	840	320	280	190	180
2 STA 4060	1320	910	830	640	250	280	190	180
3 STA 4060	1730	910	1240	640	250	280	190	180
3 STA 4676	1910	1070	1420	800	250	280	190	180
4 ST 4060	1320	1510	830	1240	250	280	190	180
6 ST 4060	1730	1510	1240	1240	250	330	280	250
2 STA 4060 OLD	1320	910	830	640	-	0	320	280
3 STA 4060 OLD	1730	910	1240	640	-	0	320	280
4 ST 4060 OLD	1320	1510	830	1240	-	0	320	280

OLD STYLE is equipped with wood-storage base h 700 mm

3 x h18

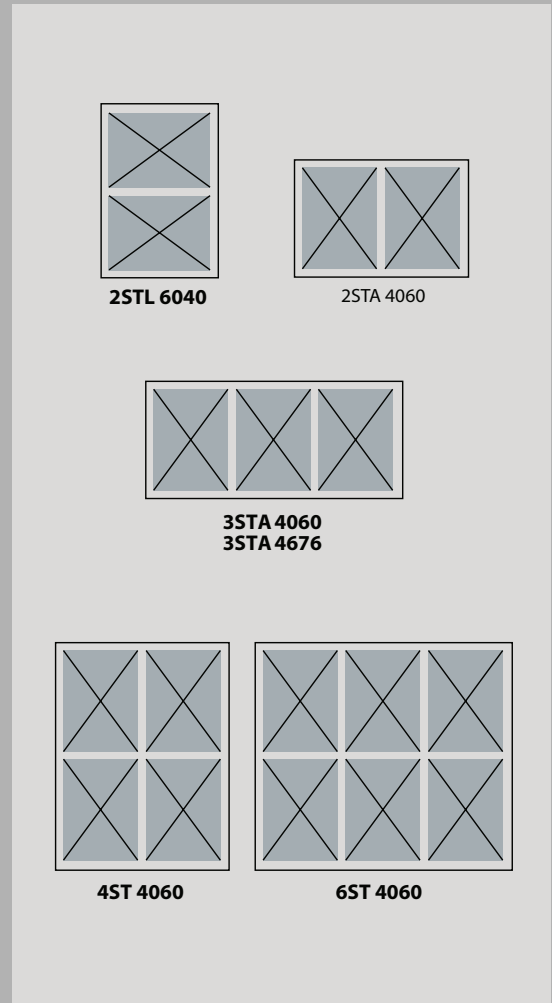

	Pan capacity		Pizza capacity		Electrical power standard	Power el. max (Super Power)	Power line
	n°	mm	Ø28 n°	Ø32 n°			
	2 STL 6040	2	600x400	5	3	4,2	7,3
2 STL 6040 Proofer	16	1,6		1,6	230/1~/50		
2 STA 4060	2	400x600	5	3	4,4	7,4	400/3N~/50
2 STA 4060 Proofer	24		1,6	1,6	230/1~/50		
3 STA 4060	3	400x600	8	5	6,5	11	400/3N~/50
3 STA 4060 Proofer	24		1,6	1,6	230/1~/50		
3 STA 4676	3	460x800	11	7	9,2	16,2	400/3N~/50
3 STA 4676 Proofer	16		1,6	1,6	230/1~/50		
4 ST 4060	4	400x600	11	6	7,2	13,1	400/3N~/50
4 ST 4060 Proofer	24		1,6	1,6	230/1~/50		
6 ST 4060	6	400x600	16	10	8,5	15	400/3N~/50
6 ST 4060 Proofer	24		1,6	1,6	230/1~/50		
2 STA 4060 OLD - 3 x h18	2x3	400x600	5x3	3x3	13,6	22,6	400/3N~/50
3 STA 4060 OLD - 3 x h18	3x3	400x600	8x3	5x3	19,9	33,4	400/3N~/50
4 ST 4060 OLD - 3 x h18	4x3	400x600	11x3	6x3	22,6	39,7	400/3N~/50

Images, measurements and technical data are not binding, and are therefore subject to change without notice.



45 Garema Circuit, Kingsgrove NSW 2208 Australia
 t. +61 2 9740 5122 f. +61 2 9740 5237
 e. info@rvo.com.au

