

# edhard

## Equipment and Accessory Guide

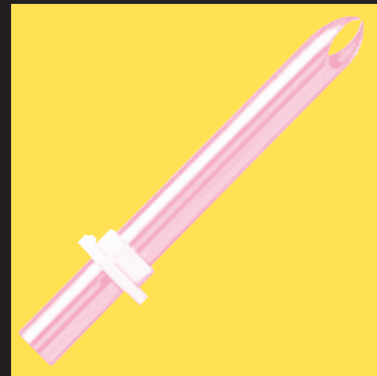
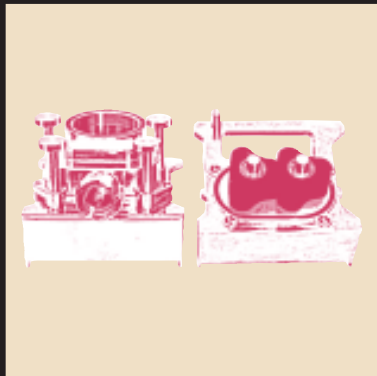
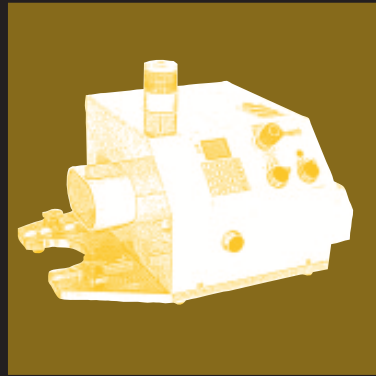
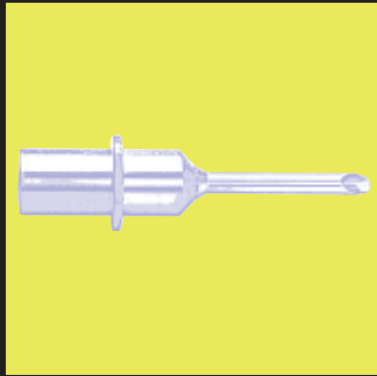
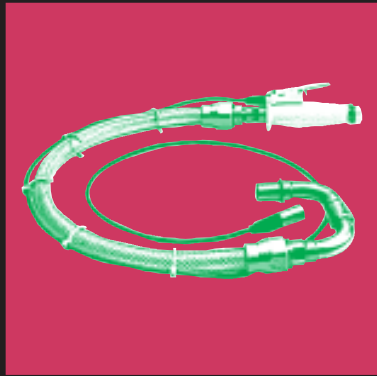
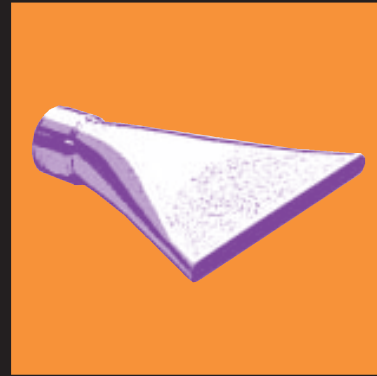
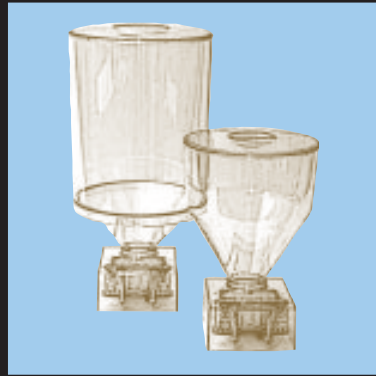
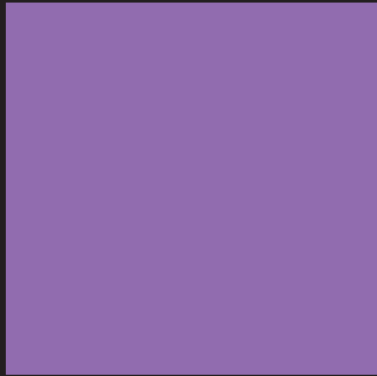

# WELCOME

We welcome all newcomers to the world of Edhard!

Due to the versatility of our equipment and systems we have arranged the following concepts to help guide you in making a decision or, at least, give you an understanding of the type of information your Edhard representative will need in order to determine the best equipment to satisfy your requirements.

Before looking through this brochure please take some time to think about the following conditions and answer the questions.

## Dosing action

- \* Inject - 1 or 2 at a time
- \* Deposit - 1, 2 or 4 at a time
- \* Fill - Jars, Bottles, Containers, etc.
- \* Transfer

## Product characteristics

- \* Is it smooth or does it have inclusions/particles?
  - \* If it has particles - what are their size and ratio to overall product?
- \* What is the product's viscosity or thickness?
- \* Is it whipped and airy?
- \* At what temperature is it to be dispensed - chilled, room temp, hot?
- \* Does the product flow? Does a mound of it collapse and level or does it hold a shape?

## Dosage amount

- \* Fractions of an ounce to pounds
- \* Grams to Kilograms

## Pan or container configuration and size

- \* 2-4 at a time - center to center spacing

## Typical production run volume

- \* Quantity of finished products produced daily.
- \* Multiple mixing bowls? How many?
- \* Expected equipment usage time daily / weekly.

The above information coupled with an understanding of the terminology on the following pages will help you navigate this product listing and help your Edhard representative best understand your needs.

# EDHARD TERMINOLOGY



## POWER BASE

Cream-colored unit that houses electronics and motor. Engages *Pump* or *Filler Unit* and causes them to accurately dispense product. Keypad controls the amount of product dispensed, cycle-type and, in some models, the speed of output. Available in 3 models of table-top unit (**P-**, **PS-** & **PV-Series**) as well as the cart-mounted unit (**PT-Series**).



## FILLER UNIT

A Lexan *Hopper* and *Pump Housing* combination coupled with a Pump Cover Assembly and *Gear-Type Impellers*. The *Pump Housing* and *Hopper* are permanently fused together. *Filler Units* refer to the **F-** and **FHP-Series**. Accept a wide variety of *Spouts* and *Attachments*. **F-Series** available in *Single* and *Double Outlet* while **FHP-Series** available in *Single Outlet* only. Used for loose to medium viscosity products.



## PUMP

A stainless steel, *Single Outlet* unit that houses either *Gear-Type* or *Lobe-Type Impellers* and accepts a wide variety of Lexan and stainless steel *Hoppers* or a *Suction Tube* (**FT-** & **FTR-Series** only). Can dispense a wide range of viscosities. Used solely on higher output *Power Bases* (**PS-**, **PV-** and **PT-Series**).



## HOPPER

Funnel constructed of either Lexan or stainless steel, which threads or clamps onto a stainless steel *Pump*. Available in 6(5.5), 10(9.5), 18(17) and 36Qt.(34L) capacities.



## DOUBLE OUTLET

Refers to the number of exit holes on a *Filler Unit*. *Double Outlet Filler Units* accept only *Spouts* with 7/16" (11.1mm) Dia. necks. These units are used primarily for injecting product into a baked good (think donut or eclair filling).



## SINGLE OUTLET

Refers to the number of exit holes on a *Filler Unit* or *Pump*. *Single Outlet Filler Units* and *Pumps* only accept *Spouts* with 7/8" (22.2mm) Dia. necks. These units are primarily used for depositing or layering product into containers (pans, bags, tubes etc.) or onto other products (cakes, muffins, pie crusts, bagels etc.). Far more versatile in application than the *Double Outlet*.



## SPOUT

Any output attachment that enables you to inject, deposit, layer or otherwise dispense product from a *Filler Unit* or *Pump*.

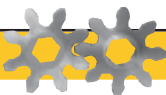

## GEAR-TYPE

Refers to the type of *Impeller* with 6 or more teeth. Used for smooth products of varying viscosities. Standard in the **F-** & **FHP-Series Filler Units** and **FS-** & **FT-Series Pumps**. Available materials include: Polypropylene, UHMW, Nylon, PEEK & Stainless



## LOBE-TYPE

Refers to the type of *Impeller* with 2 to 3 rounded lobes as opposed to traditional gear teeth. Used for smooth products as well as products with suspended particles. The maximum size of particles that can be passed without crushing is approximately 3/8" (9.6mm) Dia. (**RP-Series**) and up to 1/2" (12.7mm) Dia. (**FTR-Series**). Effective with medium to higher viscosities. Standard in the **RP-** and **FTR-Series Pumps**. Available materials include: Viton, Stainless Steel & PEEK.

# KEY

## P-, PS- & PV-Series

F F

**FILLER UNIT:** Sits on the *Power Base* and is available in Lexan. Accepts either one 7/8"Ø (22.2mm) **S** or two 7/16"Ø (11.1mm) **D** spouts. **F-Series** used for lighter, less viscous products. **FHP-Series** used for a wider range including more viscous and even semi-liquid products.

P

**PUMP:** Sits on the *Power Base* and is available in Stainless Steel. Accepts one 7/8"Ø (22.2mm) **S** spout. **FS-Series** uses 6-tooth Gear-type Impellers for smooth products. **RP-Series** uses Lobe-type Impellers for wider range of products including those with particles up to 3/8"Ø (9.6mm). Both accept removeable Hoppers **H** in either Lexan or Stainless Steel.

H

**HOPPER:** Attaches to Pump **P**. Available in 6Qt. (5L) and 18Qt. (17L) *Lexan* or 10Qt. (9L), 18Qt. (17L) and 36Qt. (34L) *Stainless Steel*.

P J

**HOPPER ACCESSORY:** *Pressure Disc* keeps stiff products from cavitating. *Heating Jackets* help maintain temperature in *Stainless Steel Hoppers*.

D S

**SPOUT:** Fits *Filler Units* and *Pumps* and available as either *Double Output* : 7/16"Ø (11.1mm) neck or *Single Output* : 7/8"Ø (22.2mm) neck.

T T

**THREADED ADAPTOR:** *Orifices* and *Adaptors* available in two thread sizes - 3/4" (19mm) and 7/8" (22.2mm).

C

**CUPCAKE SPOUT:** *Stainless Steel Cupcake Spout* with 4 down-spouts and various center-to-center spacings. Available in two thread sizes - 3/4" (19mm) and 7/8" (22.2mm).

A

**POWER BASE ACCESSORY:** Various accessories that fit any tabletop *Power Base*.

# KEY

## PT-Series

P

**PUMP:** Sits on the *Power Base* and is available in Stainless Steel. Accepts *Adaptors* **A** with sanitary flanges. **FT-Series** uses Gear-type Impellers for smooth products. **FTR-Series** uses two Lobe-type Impellers for wider range of products including those with particles up to 1/2"Ø (12.7mm). Both types can accept a removeable Stainless Steel *Hopper* **H** (for viscous products) or a *Suction Tube* **S** (for less viscous and even semi-liquid products).

S

**SUCTION TUBE:** Attaches to *Suction-type Pump* **P** and allows product to be dosed from any size mixing bowl or drum. Available in 1-1/4"Ø (w/ check valve for loose, runny products) or 2"Ø (w/out check valve for thicker products).

H

**HOPPER:** Attaches to *Hopper-type Pump* **P** and used for more viscous products. Available in 18Qt. (17L) and 36Qt. (34L) Stainless Steel.

A

**ADAPTOR:** Mates various types of *Spouts, Elbows or Hoses* **S E H** to any *FT- or FTR-Series Pump* **P**.

S

E

H

**OUTPUT ACCESSORY:** Various *Spouts, Elbows and Hose Assemblies* to finish off the depositing system.

## CDR-Series

P

**PUMP:** Sits on *Power Base* and is available in Gear-type and Lobe-type versions. Accepts Stainless Steel and Lexan *Hoppers* **H** in 18Qt. (17L) or 36Qt. (34L) capacities. Comes standard with *De-aerator* and *Bleeder Tube*. Accepts *CDR-type Hose Assembly*.

G

**DECORATING GUN:** Available in Pistol-type or Straight-type depending on user's preference. Pistol-type available in righthanded and lefthanded versions. Both types will accept most sizes and types of decorating tips through the use of our specially designed Adaptors.

H

**HOSE ASSEMBLY:** Made to fit CDR-type Pumps **P**.

## Tabletop Power Bases



**P-4010:** 120VAC · 60/50Hz · 1/37Hp (20.2W) motor  
Power Base · Model MK

What fits me?

F A



**P-4012:** 120VAC · 60/50Hz · 1/15Hp (49.7W) motor  
**P-4012-HS:** 120VAC · 60/50Hz · 1/15Hp (49.7W) motor w/ 240RPM output  
**P-4020:** 220VAC · 50/60Hz · 1/17Hp (43.9W) motor - Specify power cord plug type:  
Australian, Euro, Italian, UK

What fits me?

F F A

Power Base · Model MKH

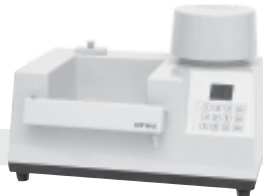

**PS-4028:** 120VAC · 60/50Hz · 1/8Hp (93.2W) motor  
**PS-4030:** 220VAC · 50/60Hz · 1/8Hp (93.2W) motor - Specify power cord plug type:  
Australian, Euro, Italian, UK

What fits me?

F F P A

Power Base · Model MKS



**PV-4000:** 120VAC · 50/60Hz · 1/4Hp (186.4W) motor  
**PV-4001:** 220VAC · 50/60Hz · 1/4Hp (186.4W) motor - Specify power cord plug type:  
Australian, Euro, Italian, UK

What fits me?

F F P A

Power Base · Variable Speed · Model MKV

## Pumps and Filler Units

F F P H



**F-5000:** 6 Qt. (5.5L) capacity w/ 2 x F-3076 spouts  
**F-5001:** 6 Qt. (5.5L) capacity w/ 2 x F-3011 spouts  
**F-5001 N/S:** 6 Qt. (5.5L) capacity w/ no spouts  
**F-5005:** 18 Qt. (17L) capacity w/ 2 x F-3011 spouts  
**F-5005 N/S:** 18 Qt. (17L) capacity w/ no spouts

What fits me?

D

F Filler Unit · Lexan · Double Outlet

OPTION



**F-3616:** Higher strength replacement cover for Lexan DoubleOutlet Filler Units

Pump Cover · Teflon-coated Aluminum · Double Outlet



**F-5003:** 6 Qt. (5.5L) capacity  
**F-5007:** 18 Qt. (17L) capacity

What fits me?

S

F Filler Unit · Lexan · Single Outlet

OPTION



**F-3615:** Higher strength replacement cover for Lexan SingleOutlet Filler Units

Pump Cover · Teflon-coated Aluminum · Single Outlet



**FHP-5025:** Gear-Type 18 Qt. (17L) capacity  
**FHP-5026:** Gear-Type 6 Qt. (5.5L) capacity  
**FHP-5031:** Gear-Type 18 Qt. (17L) capacity w/ Pressure Disc

What fits me?

S P

F Filler Unit · Lexan · Single Outlet - High Pressure

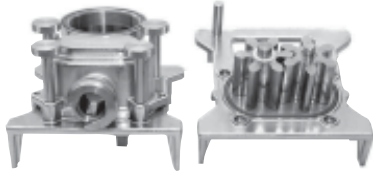

**FS-3153:** Gear-Type Stainless Impellers  
**FS-3414:** Gear-Type Nylon Impellers

What fits me?

H S

**P** Pump · *Stainless Steel* · Single Outlet

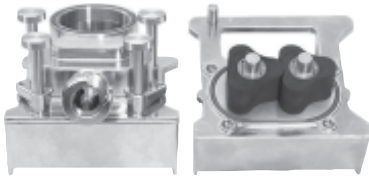

**RP-3160:** Lobe-Type Viton 3-Lobe Impellers  
**RP-3527:** Lobe-Type PEEK 3-Lobe Impellers  
**RP-3514:** Lobe-Type Stainless 3-Lobe Impellers (High Heat)

What fits me?

H S

**P** Pump · *Stainless Steel* · Single Outlet

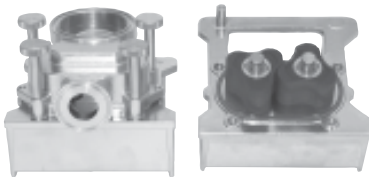

**RP-3521:** Lobe-Type Viton 3-Lobe Impellers w/ Sanitary Outlet

What fits me?

H A

**P** Pump · *Stainless Steel* · Single Outlet

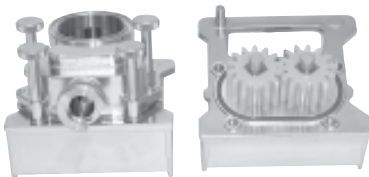

**RP-3529:** Gear-Type PEEK Impellers - For Liquids

What fits me?

H S

**P** Pump · *Stainless Steel* · Single Outlet



**FS-3155:** 6 Qt. (5.5L) capacity  
**FS-3150:** 18 Qt. (17L) capacity

What fits me?

P

**H** Hopper · *Lexan* · for use on FS- and RP-Series Pumps



**FS-2342:** 10 Qt. (9.5L) capacity  
**FS-2313:** 18 Qt. (17L) capacity w/ 30° neck  
**FS-2447:** 18 Qt. (17L) capacity w/ 45° neck  
**FS-2748:** 36 Qt. (34L) capacity

What fits me?

J P

**H** Hopper · *Stainless Steel* · for use on FS- and RP-Series Pumps



Accessories and Spouts **A P J D S T T C****A** Footswitch**P-3026:**  
**NOTE:**Footswitch for remote operation of all Power Bases  
For Footswitches to fit older model Power Bases please  
contact us for the proper connector type.**A** Bridge**P-3634:**

Used to raise any table-top Power Base over the work surface.

**A** Balancer Assy.**PS-3328:**

Used to counterbalance a Hose Assy. on any table-top Power Base

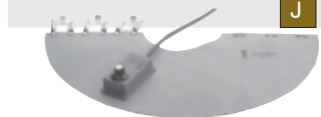
**P** Pressure Disc**FHP-3368:**  
**FS-3202:**  
**FS-3301:**Lexan for use with 18 Qt. (17L) FHP-Series Filler Unit or FS-3150  
Stainless Steel for use with 18 Qt. (17L) S.S. Hopper w/ 45° neck  
Stainless Steel for use with 36 Qt. (34L) Hopper**J** Heating Jacket · Variable temperature**FS-3269:**  
**FS-3270:**  
**FS-3271:**  
**FS-3272:**120VAC · Lower section for use on 18 Qt. (17L) S.S. Hopper w/ 30° neck  
120VAC · Upper section for use on 18 Qt. (17L) S.S. Hopper  
240VAC · Lower section for use on 18 Qt. (17L) S.S. Hopper w/ 30° neck  
240VAC · Upper section for use on 18 Qt. (17L) S.S. Hopper**S** Spout · 7/8" Threaded Tip**FS-3148:**Hose Assy. · 7/8" Threaded Tip - 36"(914M) long for use on  
F-, FS- and RP-Series Pumps**CUSTOM:**

Hose Assy. · 7/8" Threaded Tip - Specify Length

What fits me?

**D T**



**F-3011:** *Donut* · 7/16"Ø x 3-1/2"L (11.1mm x 89mm)**D** Spout · Double Outlet · Standard Tip**F-3012:** *Eclair-Slit* · 7/16"Ø x 5"L (11.1mm x 127mm)**D** Spout · Double Outlet · Standard Tip**F-3013:** *Eclair* · 7/16"Ø x 5"L (11.1mm x 127mm)**D** Spout · Double Outlet · Standard Tip**F-3065:** *Long John-Slit* · 5/16"Ø x 4-3/8"L (79mm x 111.1mm)**D** Spout · Double Outlet · Standard Tip**F-3064:** *Long John* · 5/16"Ø x 4-3/8"L (79mm x 111.1mm)**D** Spout · Double Outlet · Standard Tip**F-3014:** *Blueberry* · 7/16"Ø x 3-1/4"L (11.1mm x 82.5mm)**D** Spout · Double Outlet · 30° Tip**F-3076:** *Munchkin* · 9/32"Ø x 2-1/4"L (71mm x 57.1mm)**D** Spout · Double Outlet · 30° Tip**F-3066:** *Frenchie* · 3/16"Ø x 1-5/8"L (4.8mm x 41.3mm)**D** Spout · Double Outlet · 30° Tip**F-3081:** *Berliner* · 1/4"Ø x 1-5/8"L (6.4mm x 41.3mm)**D** Spout · Double Outlet · 30° Tip



Spout · Standard Tip

**F-3094:***Donut* · 7/16"Ø x 3-1/2"L (11.1mm x 89mm)

Spout · Standard Tip

**F-3092:***Eclair-Slit* · 7/16"Ø x 5"L (11.1mm x 127mm)

Spout · Standard Tip

**F-3091:***Eclair* · 7/16"Ø x 5"L (11.1mm x 127mm)

Spout · Standard Tip

**F-3096:***Long John-Slit* · 5/16"Ø x 4-3/8"L (7.9mm x 111.1mm)

Spout · Standard Tip

**F-3095:***Long John* · 5/16"Ø x 4-3/8"L (7.9mm x 111.1mm)

Spout · 30° Tip

**F-3090:***Blueberry* · 7/16"Ø x 3-1/4"L (11.1mm x 82.5mm)

Spout · 30° Tip

**F-3097:***Munchkin* · 9/32"Ø x 2-1/4"L (7.1mm x 57.1mm)

Spout · 30° Tip

**F-3339:***Frenchie* · 3/16"Ø x 1-5/8"L (4.8mm x 41.3mm)

Spout · 90° Tip

**F-3067:***Plain* · 7/8"Ø x 7"L (22.2mm x 177.8mm)

Spout · 90° Tip

**F-3055:***Cannoli* · 9/16"Ø x 3"L (14.3mm x 76.2mm)



**F-3043:** 45° · 7/8"Ø x 4-3/4"L (22.2mm x 120.6mm)

**S** Spout · 90° Tip



**F-3042:** Croissant · 3/16"Ø x 1"L - 4 places (4.8mm x 25.4mm)

**S** Spout · Multi Tip



**F-3101:** Triple · 3/16"Ø x 1"L - 3 places (4.8mm x 25.4mm)

**S** Spout · Multi Tip



**FS-3305:** Double Spout Manifold · for use on FS- and RP-Series Pumps with any Double Outlet Spout

**S** Manifold

What fits me?

**D**



**F-3041:** Cupcake · 3/4"Ø x 3-1/4"Spacing (19mm x 82.5mm)  
**F-3103:** Cupcake · 3/4"Ø x 3-1/2"Spacing (19mm x 89mm)  
**F-3072:** Cupcake · 3/4"Ø x 4"Spacing (19mm x 101.6mm)

**S** Spout · 3/4" Threaded Tip

What fits me?

**T**



**F-3141:** Universal Extension · 7/8"Ø x 6-1/4"L (22.2mm x 158.7mm)  
**F-3391:** Universal Extension · 7/8"Ø x 12-1/4"L (22.2mm x 311.1mm)  
**CUSTOM:** Universal Extension · 7/8"Ø x Specify Length

**S** Spout · 7/8" Threaded Tip

What fits me?

**T**



**FS-3335:** Hose Assy. · 7/8"Threaded Tip - 36"(914M) long w/ F-3141 Extension wand for use on F-, FS- & RP-Series Pumps  
**CUSTOM:** Hose Assy. · 7/8"Threaded Tip - Specify Length

**S** Spout · w/ Stainless Extension and 7/8" Threaded Tip

What fits me?

**S T**



- FS-3277:** Cupcake · 7/8"Ø x 4-3/4"L (22.2mm x 120.6mm)  
**FS-3393:** Cupcake · 7/8"Ø x 8"L (22.2mm x 203.2mm)  
**FS-3394:** Cupcake · 7/8"Ø x 10.5"L (22.2mm x 266.7mm)  
**CUSTOM:** Cupcake · 7/8"Ø x Specify Length

**S** Spout · Extension

What fits me?

**C**



- F-3472:** Cupcake · 3/4"Ø x 2-1/4"Spacing (19mm x 57.15mm)  
**F-3590:** Cupcake · 3/4"Ø x 2-3/8"Spacing (19mm x 60.33mm)  
**F-3473:** Cupcake · 3/4"Ø x 2-1/2"Spacing (19mm x 63.5mm)  
**F-3389:** Cupcake · 3/4"Ø x 2-3/4"Spacing (19mm x 68.85mm)  
**F-3405:** Cupcake · 3/4"Ø x 3-1/4"Spacing (19mm x 82.55mm)  
**F-3556:** Cupcake · 3/4"Ø x 3-1/2"Spacing (19mm x 88.9mm)  
**F-3474:** Cupcake · 3/4"Ø x 3-5/8"Spacing (19mm x 92.07mm)  
**F-3406:** Cupcake · 3/4"Ø x 4"Spacing (19mm x 101.6mm)  
**F-3562:** Cupcake · 3/4"Ø x 4-1/8"Spacing (19mm x 104.78mm)  
**F-3390:** Cupcake · 3/4"Ø x 4-1/4"Spacing (19mm x 107.95mm)  
**F-3475:** Cupcake · 3/4"Ø x 4-1/2"Spacing (19mm x 114.3mm)  
**CUSTOM:** Cupcake · Specify Spacing

**C** Spout · 3/4" Threaded Tip

What fits me?

**T**



- F-3547:** Cupcake · 7/8"Ø x 1-1/2"Spacing (22.2mm x 38.1mm)  
**F-3532:** Cupcake · 7/8"Ø x 2"Spacing (22.2mm x 50.8mm)  
**F-3533:** Cupcake · 7/8"Ø x 2-1/4"Spacing (22.2mm x 57.15mm)  
**F-3591:** Cupcake · 7/8"Ø x 2-3/8"Spacing (22.2mm x 60.33mm)  
**F-3534:** Cupcake · 7/8"Ø x 2-1/2"Spacing (22.2mm x 63.5mm)  
**F-3535:** Cupcake · 7/8"Ø x 2-3/4"Spacing (22.2mm x 69.85mm)  
**F-3560:** Cupcake · 7/8"Ø x 3"Spacing (22.2mm x 76.2mm)  
**F-3557:** Cupcake · 7/8"Ø x 3-1/4"Spacing (22.2mm x 82.55mm)  
**F-3494:** Cupcake · 7/8"Ø x 3-1/2"Spacing (22.2mm x 88.9mm)  
**F-3525:** Cupcake · 7/8"Ø x 3-5/8"Spacing (22.2mm x 92.08mm)  
**F-3559:** Cupcake · 7/8"Ø x 4"Spacing (22.2mm x 101.6mm)  
**F-3561:** Cupcake · 7/8"Ø x 4-1/8"Spacing (22.2mm x 104.78mm)  
**F-3558:** Cupcake · 7/8"Ø x 4-1/4"Spacing (22.2mm x 107.95mm)  
**F-3550:** Cupcake · 7/8"Ø x 4-1/2"Spacing (22.2mm x 114.3mm)  
**CUSTOM:** Cupcake · Specify Spacing

**C** Spout · 7/8" Threaded Tip

What fits me?

**T**



- F-3212:** Bread Roll · 3-3/8"Ø (85.7mm) w/ 7/8" Threaded Inlet

**T** Spout · Accessory



- F-3213:** Bagel · 3-3/8"Ø (85.7mm) w/ 7/8" Threaded Inlet

**T** Spout · Accessory



T

Valve

**F-3147:**

*Dripless* · 7/8" (22.2mm) Threaded Inlet

What fits me?

A



T

Valve

**F-3187:**

*Dripless - Extended* · 7/8" (22.2mm) Threaded Inlet

What fits me?

A



A

Adaptor

**F-20768:**

*Dripless - Bottle Filling* · Used on F-3187 Dripless Valve Extended to aid in filling bottles.



T

Orifice

**F-2327:**  
**FS-2397:**  
**CUSTOM:**

*Decorating Tip* · .56"Ø (14.2mm)  
*Decorating Tip* · .38"Ø (9.7mm)  
*Decorating Tip* · Specify Diameter



T

Orifice

**F-20145:**  
**F-2887:**  
**FS-2760:**  
**FS-2739:**  
**FS-2740:**  
**CUSTOM:**

*Round* · .22"Ø (5.6mm)  
*Round* · .38"Ø (9.7mm)  
*Round* · .47"Ø (12mm)  
*Round* · .56"Ø (14.2mm)  
*Rectangular* · .19 x .38" (4.8mm x 9.7mm)  
*Either Shape* · Specify Sizing



T

Orifice

**F-20761:**

*Bottle Filling* · Used to aid in the filling of small-neck bottles.



T

Adaptor

**F-3267:**

*Spout* · 7/8"(22.2mm) Thread - 7/16"Ø (11.1mm) accepts any Double Outlet Spout

What fits me?

D



T

Adaptor

**CD-3258:**  
**CD-3259:**  
**CD-3260:**  
**CD-3266:**  
**FS-3188:**

*Decorator Tip* · #0 - #3  
*Decorator Tip* · #4 - #6  
*Decorator Tip* · #7 - #9  
*Decorator Tip* · Euro  
*Decorator Tip* · Small



<b>F-3580:</b>	Double · 7/8"Ø x 1-3/16"L (22.2mm x 30.18mm)
<b>F-3578:</b>	Double · 7/8"Ø x 1-3/4"L (22.2mm x 44.45mm)
<b>F-3211:</b>	Double · 7/8"Ø x 2"L (22.2mm x 50.8mm)
<b>F-3537:</b>	Double · 7/8"Ø x 2-1/2"L (22.2mm x 63.5mm)
<b>F-3538:</b>	Double · 7/8"Ø x 2-3/4"L (22.2mm x 69.85mm)
<b>F-3541:</b>	Double · 7/8"Ø x 3"L (22.2mm x 76.2mm)
<b>F-3540:</b>	Double · 7/8"Ø x 3-1/4"L (22.2mm x 82.55mm)
<b>F-3496:</b>	Double · 7/8"Ø x 3-1/2"L (22.2mm x 88.9mm)
<b>F-3478:</b>	Double · 7/8"Ø x 4"L (22.2mm x 101.6mm)
<b>F-3479:</b>	Double · 7/8"Ø x 4-1/2"L (22.2mm x 114.3mm)
<b>F-3588:</b>	Double · 7/8"Ø x 5"L (22.2mm x 127mm)
<b>F-3589:</b>	Double · 7/8"Ø x 5-1/2"L (22.2mm x 139.7mm)
<b>CUSTOM:</b>	Double · 7/8"Ø x Specify Spacing

What fits me?

T

T Spout · Accessory · Threaded Tip

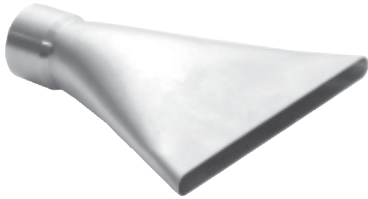

<b>F-2861:</b>	Layering · 1.19"L x .14"W (30mm x 3.6mm)
<b>F-2419:</b>	Layering · 1.6"L x .08"W (40.6mm x 2mm)
<b>F-2497:</b>	Layering · 1.6"L x .16"W (40.6mm x 4mm)
<b>F-2585:</b>	Layering · 1.97"L x .10"W (50mm x 2.54mm)
<b>F-2418:</b>	Layering · 2.36"L x .12"W (60mm x 3mm)
<b>F-2591:</b>	Layering · 2.76"L x .12"W (70mm x 3mm)
<b>F-2696:</b>	Layering · 2.76"L x .14"W (70mm x 3.6mm)
<b>F-2592:</b>	Layering · 3.15"L x .10"W (80mm x 2.54mm)
<b>F-2695:</b>	Layering · 3.15"L x .14"W (80mm x 3.6mm)
<b>F-2144:</b>	Layering · 3.5"L x .19"W (89mm x 4.8mm)
<b>F-20959:</b>	Layering · 3.5"L x .25"W (89mm x 6.4mm)
<b>F-2267:</b>	Layering · 4"L x .28"W (101.6mm x 7.1mm)
<b>F-20842:</b>	Layering · 4.33"L x .078"W (110mm x 2mm)
<b>F-20843:</b>	Layering · 4.33"L x .393"W (110mm x 10mm)
<b>CUSTOM:</b>	Layering · Specify Length x Width

T Spout · Accessory



<b>FS-3392:</b>	7/8" Thread to 7/8"Ø · Used to mate Single Outlet Spouts to a 7/8" threaded tip (Ex. F-3141)
-----------------	--

T Adaptor

What fits me?

S



<b>F-3577:</b>	Double · 3/4"Ø x 1-3/4"L (19mm x 44.45mm)
<b>F-3602:</b>	Double · 3/4"Ø x 3"L (19mm x 76.2mm)
<b>F-3539:</b>	Double · 3/4"Ø x 3-1/4"L (19mm x 82.55mm)
<b>F-3140:</b>	Double · 3/4"Ø x 4-1/2"L (19mm x 114.3mm)
<b>CUSTOM:</b>	Double · 3/4"Ø x Specify Spacing

T Spout · Accessory · Threaded Tip

What fits me?

T



<b>F-3142:</b>	Dripless · 3/4" (19mm) Threaded Inlet
----------------	---------------------------------------

T Valve



<b>F-3214:</b>	Dripless - Extended · 3/4" (19mm) Threaded Inlet
----------------	--

T Valve

# PT-SERIES

The Edhard PT-Series is a stand-alone system that can be used as a dosing pump and also as a transfer pump. Its reversible motor means that this system can be used with a suction tube (for looser products) as well as a gravity-fed hopper (just like our table-top units).

The system is comprised of four major components -

- ① **Power Base**
- ② **Pump**
- ③ **Cart**
- ④ **Suction Tube/Hopper**

Various Accessories are available to finish off the system - Batter Spouts, Elbows, Extensions, etc.

Remember, if you don't see what you had in mind chances are good that we can manufacture something to meet your specifications.

Please call or e-mail with any questions.

## edhard

279 Blau Road · Hackettstown, NJ 07840 · USA  
 908.850.8444 · 888.edhard.1 · Fax: 908.850.8445  
 meter@edhard.com

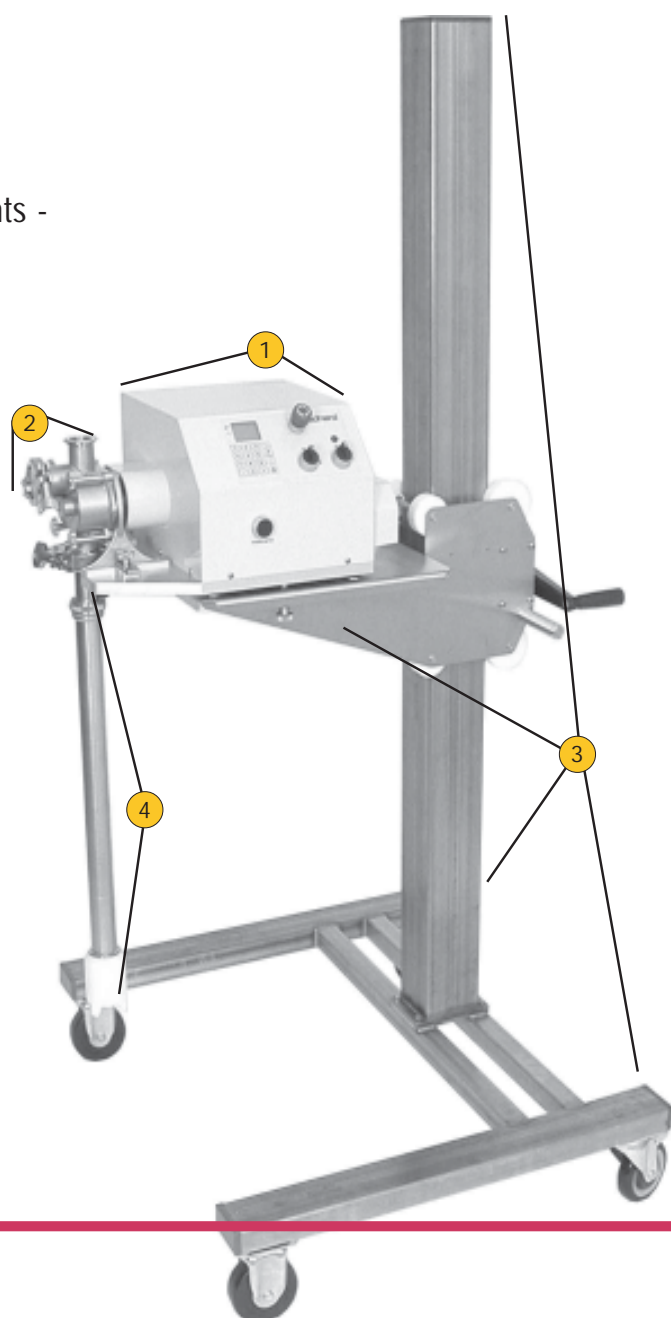



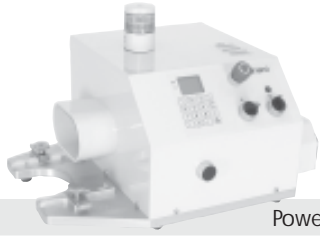

- PT-4035:** 200W motor 120VAC Model MKT
- PT-4036:** 200W motor 220VAC Model MKT
- PT-4037:** 400W motor 220VAC Model MKT

What fits me?

P

Power Base · Variable Speed · Transfer Type



- PT-8010:** Stainless Steel · for use with PT-Series Power Bases

Cart



- PT-3381:** Used to counterbalance a Hose Assembly- attaches to column of PT-8010

Balancer Assembly



- FT-3342:** Gear-Type Stainless and Nylon Impellers
- FT-3465:** Gear-Type PEEK Impellers

P Pump · Suction · Stainless Steel

What fits me?

A S



- FT-3343:** Lobe-Type Viton 3-Lobe Impellers

P Pump · Suction · Stainless Steel

What fits me?

A S



- FT-3375:** 1-1/4"Ø w/ ball check valve
- FT-3430:** 2"Ø w/out ball check valve

S Suction Tube



**FT-3366:** Gear-Type Stainless and Nylon Impellers  
**FT-3466:** Gear-Type Stainless Impellers  
**FT-3470:** Gear-Type PEEK Impellers · for Low-Viscosity products  
**FT-3573:** Gear-Type PEEK Impellers · Single Outlet Housing

What fits me?  
A H

P Pump · Hopper Feed · Stainless Steel



**FTR-3371:** Lobe-Type Viton 3-Lobe Impellers

What fits me?  
A H

P Pump · Hopper Feed · Stainless Steel

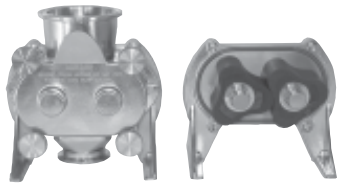

**FTR-3516:** Lobe-Type Viton 3-Lobe Impellers · Single Outlet Housing

What fits me?  
A H

P Pump · Hopper Feed · Stainless Steel



**FT-20064:** 18 Qt. (17L) capacity w/ 45° neck  
**FT-20065:** 18 Qt. (17L) capacity w/ 30° neck  
**FT-20131:** 36 Qt. (34L) capacity

What fits me?  
J P

H Hopper · Stainless Steel · for use on FT- and FTR-Series Pumps



**FT-3520:** Manifold · Double · 4" (101.6mm) spacing - sanitary connections

What fits me?  
S A

A Adaptor



**FT-3399:** Sanitary Fitting to 7/8" Ø (22.2mm) · used to mate Single Outlet Spouts to FT- or FTR-Series Pumps

What fits me?  
S

A Adaptor



**FT-20176:** Hose to Sanitary Fitting · used to mate Hose Assy. to FT- or FTR-Series Pumps

What fits me?  
H

A Adaptor



**FT-3586:** Connector · used to mate FT-Series Adaptors, Elbows, Batter & Cupcake spouts to FT- or FTR-Series Pumps

What fits me?  
S E

A Adaptor

**A** Adaptor

**FT-3377:** *Universal Extension · 1-1/8"Ø x 18-1/2"L (28.6mm x 470mm)*  
**CUSTOM:** *Universal Extension · 1-1/8"Ø x Specify Length*

What fits me?

S E

**E** Elbow · *Threaded Tip*
**FT-3379:** *Universal Extension to 7/8" Thread · 1-1/8"Ø - 7/8"Thread (28.6mm - 22.2mm)*

What fits me?

T

**E** Elbow · *for use w/ F-Series Stainless Cupcake Spouts*
**FT-3386:** *Universal Extension to Cupcake Spout · 1-1/8"Ø - 7/8"Ø (28.6mm - 22.2mm)*

What fits me?

C

**E** Elbow · *for use w/ FT-Series Stainless Cupcake Spouts*
**FT-3378:** *Universal Extension to Cupcake Spout · 1-1/8"Ø - 1-1/8"Ø (28.6mm - 28.6mm)*

What fits me?

S

**S** Spout

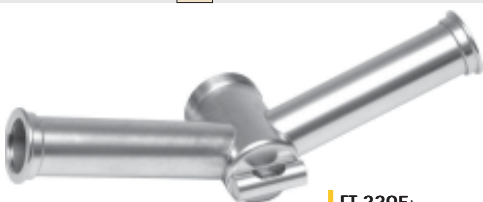
**FT-20217:** *Batter*

**S** Spout

**FT-3395:** *Double Batter*

**S** Spout

**FT-3376:** *Dripless Cupcake · 3-1/4" (82.55) spacing*  
**CUSTOM:** *Dripless Cupcake · Specify spacing*



- FT-3563:** Cupcake · 3/4"Ø x 3-1/4"Spacing (11.1mm x 82.55mm)
- FT-3570:** Cupcake · 7/8"Ø x 2-3/4"Spacing (22.2mm x 69.85mm)
- FT-3569:** Cupcake · 7/8"Ø x 3-1/4"Spacing (22.2mm x 82.55mm)
- FT-3568:** Cupcake · 7/8"Ø x 3-3/8"Spacing (22.2mm x 85.73mm)
- FT-3567:** Cupcake · 7/8"Ø x 3-5/8"Spacing (22.2mm x 92.08mm)
- FT-3566:** Cupcake · 7/8"Ø x 4"Spacing (22.2mm x 101.6mm)
- FT-3565:** Cupcake · 7/8"Ø x 4-1/8"Spacing (22.2mm x 104.78mm)
- FT-3571:** Cupcake · 7/8"Ø x 4-1/4"Spacing (22.2mm x 107.95mm)
- FT-3564:** Cupcake · 7/8"Ø x 4-3/8"Spacing (22.2mm x 111.13mm)
- CUSTOM:** Cupcake · Specify Spacing

What fits me?

T T

**S** Spout · 3/4" or 7/8" Threaded Tip



- FT-3402:** Hose Assy. · 7/8"Threaded Tip - 36"(.914M) long
- CUSTOM:** Hose Assy. · 7/8"Threaded Tip - Specify Length

What fits me?

D T

**H** Spout



- FT-3548:** Hose Assy. · 7/8"Threaded Tip - 36"(.914M) long w/ F-3141 Extension wand for use on FT- & FTR-Series Pumps
- CUSTOM:** Hose Assy. · 7/8"Threaded Tip - Specify Length

What fits me?

S T

**H** Spout



- FT-3617:** Bundt · 4x7/8"Ø on a 3-1/2"Ø (4x22.2mm x 88.9mm)
- CUSTOM:** Bundt · 4x7/8"Ø x Specify Diameter

What fits me?

T

**S** Spout · 7/8" Threaded Tip

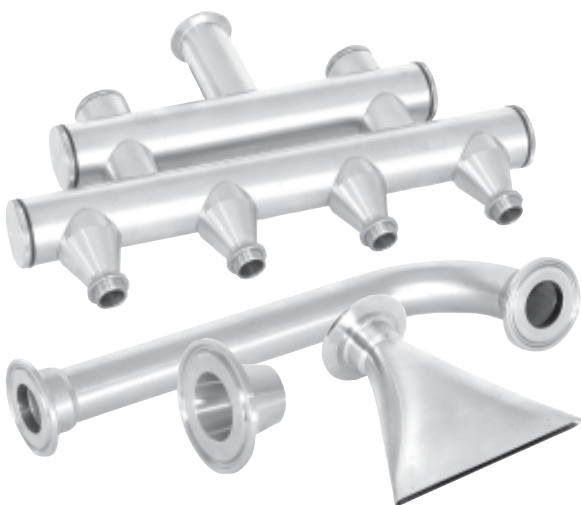

- CUSTOM:** Spouts/Extensions/Orifices · Specify product, application, size, etc.

**A E S** Custom

# CDR-SERIES

The Edhard CDR-Series is a table-top system that can be used to ice and decorate cakes, create buttercream ornaments, and dispense various petitshue and spritz cookie batters.

Its lack of a dosing function differs this series from the rest of our systems - the product will dispense as long as the trigger is pulled giving the operator artistic freedom when looks are more important than portion control.

The system is comprised of five major components -

- ① **Power Base**
- ② **Pump**
- ③ **Balancer**
- ④ **Hose/Decorating Gun**
- ⑤ **Hopper/Pressure Disc**

A couple of gun styles and orientations are available as are Adaptors to accept most sizes of decorating tips.

Please call or e-mail with any questions.

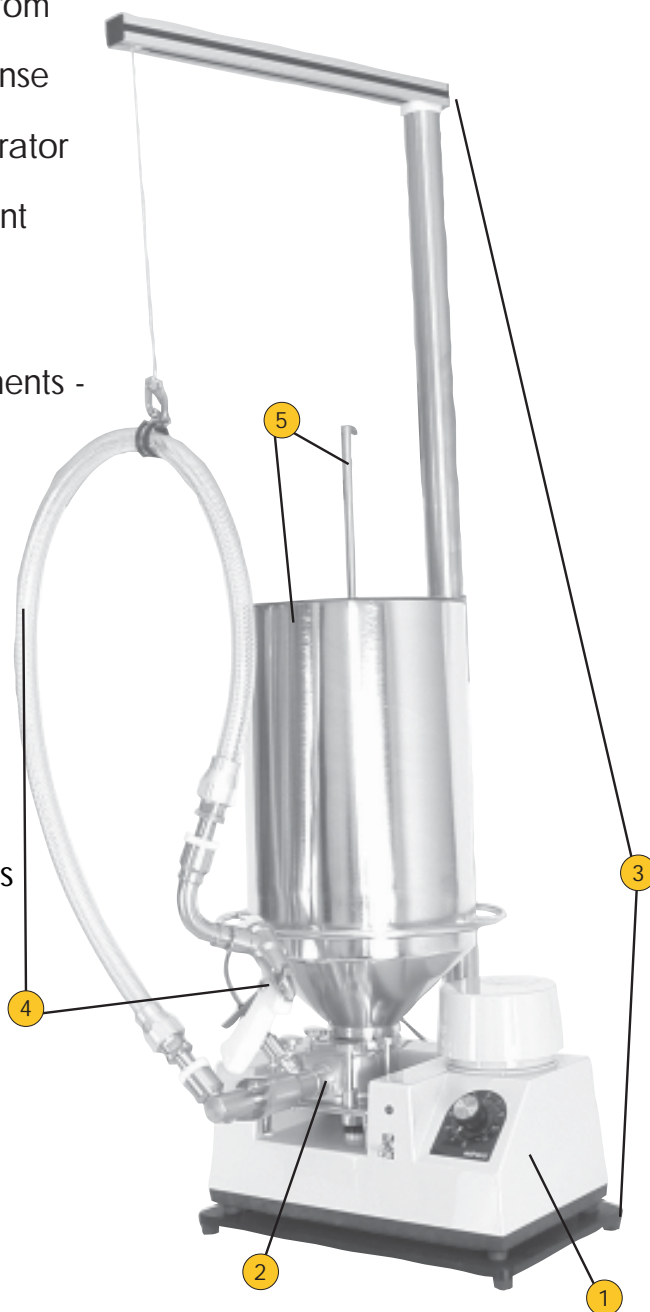

## edhard

279 Blau Road · Hackettstown, NJ 07840 · USA  
 908.850.8444 · 888.edhard.1 · Fax: 908.850.8445  
 meter@edhard.com

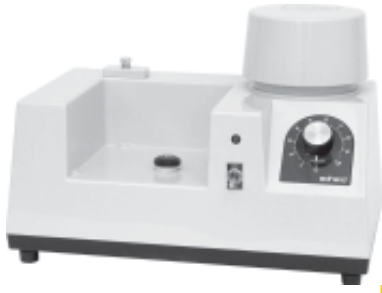

**CD-4050:** 120VAC · 60/50Hz · 1/4Hp (186.4W) motor  
**CD-4053:** 220VAC · 50/60Hz · 1/4Hp (186.4W) motor

Power Base · Model CD

What fits me?

F



**CDR-3449:** Gear-Type Stainless Steel Impellers

**P** Pump · *Stainless Steel* · Single Outlet

What fits me?

H H

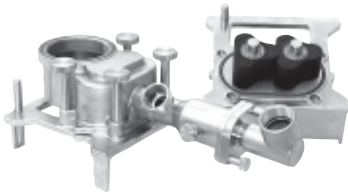

**CDR-3400:** Lobe-Type Viton 3-Lobe Impellers

**P** Pump · *Stainless Steel* · Single Outlet

What fits me?

H H



**FS-3150:** 18 Qt. (17L) capacity  
**FS-2447:** 18 Qt. (17L) capacity w/ 45° neck  
**FS-2748:** 36 Qt. (34L) capacity

**H** Hopper · *Lexan or Stainless Steel*

What fits me?

P



**FHP-3368:** Lexan for use with 18 Qt. (17L) Hopper [FS-3150]  
**FS-3202:** Stainless Steel for use with 18 Qt. (17L) Hopper [FS-2447]  
**FS-3301:** Stainless Steel for use with 36 Qt. (34L) Hopper [FS-2748]

**P** Pressure Disc



A

Balancer Assy.

CD-3252:

Used to counterbalance a Hose and Gun Assy.



H

Hose

CDR-3401:

Cake Decorator · Made specifically to fit CDR- Pumps

What fits me?

G



G

Gun · 7/8" Threaded Tip

CD-3367:

Decorating · Straight-type

What fits me?

T



G

Gun · 7/8" Threaded Tip

CD-3308:

Elbow · Pistol-type Gun

CD-3311:

Decorating · Pistol-type - Right handed

CD-3311LH:

Decorating · Pistol-type - Left handed

What fits me?

T



T

Adaptor

CD-3258:

Decorator Tip · #0 - #3

CD-3259:

Decorator Tip · #4 - #6

CD-3260:

Decorator Tip · #7 - #9

CD-3266:

Decorator Tip · Euro

FS-3188:

Decorator Tip · Small



T-4040:

120VAC · 60Hz

T-4041:

220VAC · 50Hz

Turntable · Variable speed and Reversible direction



# edhard



T. +61 2 9740 5122 F. +61 2 9740 5237  
E. [info@rvo.com.au](mailto:info@rvo.com.au)  
[www.rvo.com.au](http://www.rvo.com.au)

RVO ENTERPRISES PTY LTD  
45 Garema Circuit, KINGSGROVE NSW 2208  
ABN. 71 131 801 637