



▶ OVEN LINE

Roto Classic rack oven for bread and pastry





80 years of experience rotate around this oven

Strong with its own major technological evolution, the rack oven Rotodrago Classic is today the reference mark for performance and reliability.

▶ COMPONENTS

Polin experience in service of functionality

Combustion chamber **1** is made with a big radiant surface, thanks to the big quantity of pipes and the peculiar shape of fumes circuit.

This solution, together with thick refractory st/st structure, grants:

- high efficiency
- low consumption rates
- long-term durability

The big steam generator **2**, extending the entire interior width of the oven, guarantees a big supply of steam.

The automatic steam distribution system managed by software, in combination with constant pressure baking, keeps the surface of the product moist for a long period of time.



ROTO CLASSIC





Extreme feeding versatility: methane, lgp, gasoil, electricity.

Double-glass window with compass opening system for easy cleaning. **3**



The double stainless/silicon rubber seal on the vertical and upper wells of the door guarantees a perfectly hermetic seal. **4**



The door with double-glass has a strong and ergonomic exterior handle, to grant a perfectly hermetic seal, and an interior safety handle. **5**



The rack hooking device is made entirely out of a casting with rounded profile and large cross section (platform optional, for racks with different heights). **6**



The smooth floor makes it easy to clean inside and make the entrance of the rack easier.

Compact size for more versatility. **7**

ROTO CLASSIC























Small details, big difference

- Stainless steel side panels 8
- Automatic vapor exhaust dumper for easier and even bakings
- Stronger electric group to further increase productivity
- Stronger steam generator to further increase steam output
- Automatic lifting device for heavy racks (up to 400 kg) 9
- Rack platform



▶ KEYBOARD



| | | | | |
|---|--|-------------------------------------|-------------------------------------|-------------------------------------|
|  | BAKING PROGRAMS | 100 | 200 | 300 |
|  | PHASES FOR EACH BAKING CYCLE | 12 | 6 | 10 |
|  | DISPLAY | GRAPHIC LCD 8 rows 128X64 | GRAPHIC LCD 4,8" 320x240 | TOUCH SCREEN 7" 800x480 |
|  | PASSWORD PROTECTED RECIPES | <input checked="" type="checkbox"/> | <input checked="" type="checkbox"/> | <input checked="" type="checkbox"/> |
|  | ENERGY STAND-BY | <input checked="" type="checkbox"/> | <input checked="" type="checkbox"/> | <input checked="" type="checkbox"/> |
|  | TEMPERATURE/TIME LIMITER | <input checked="" type="checkbox"/> | <input checked="" type="checkbox"/> | <input checked="" type="checkbox"/> |
|  | AUTOMATIC SYSTEM STEAM DISTRIBUTION | <input checked="" type="checkbox"/> | <input checked="" type="checkbox"/> | <input checked="" type="checkbox"/> |
|  | AUTOMATIC START UP | <input checked="" type="checkbox"/> | <input checked="" type="checkbox"/> | <input checked="" type="checkbox"/> |
|  | ALARMS TO DISPLAY MALFUNCTIONS | <input checked="" type="checkbox"/> | <input checked="" type="checkbox"/> | <input checked="" type="checkbox"/> |
|  | FUNCTION ENERGY SAVING | <input type="checkbox"/> | <input checked="" type="checkbox"/> | <input checked="" type="checkbox"/> |
|  | DOUBLE AIR SPEED | <input type="checkbox"/> | <input checked="" type="checkbox"/> | <input checked="" type="checkbox"/> |
|  | LITER METER | <input type="checkbox"/> | <input checked="" type="checkbox"/> | <input checked="" type="checkbox"/> |
|  | DIGITAL RESERVE KEYBOARD  | <input type="checkbox"/> | <input checked="" type="checkbox"/> | <input checked="" type="checkbox"/> |
|  | AUTOMATIC STEAM EXHAUST VALVE | <input type="checkbox"/> | <input checked="" type="checkbox"/> | <input checked="" type="checkbox"/> |
|  | KEY FOR SAVING PROGRAMS | <input type="checkbox"/> | <input type="checkbox"/> | <input checked="" type="checkbox"/> |
|  | MOTORIZED VAPOR EXHAUST VALVE | <input type="checkbox"/> | <input type="checkbox"/> | <input type="checkbox"/> |
|  | HEAT ACCUMULATION SYSTEM | <input type="checkbox"/> | <input type="checkbox"/> | <input type="checkbox"/> |
|  | PROGRAM PC-NETWORK CONTROL OF MULTIPLE OVENS | | <input type="checkbox"/> | <input type="checkbox"/> |

DIMENSIONS

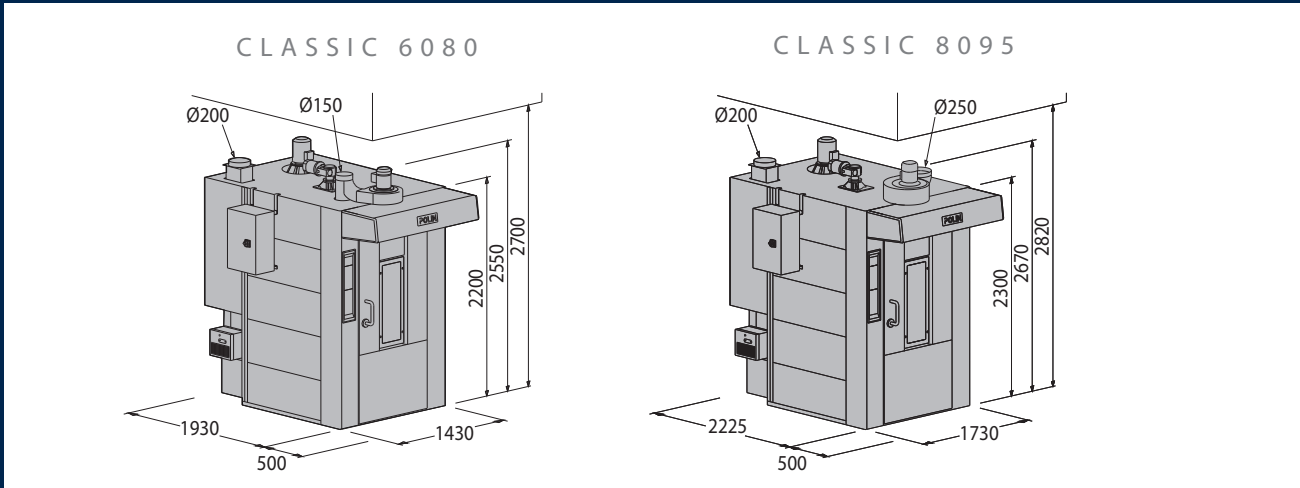

| | Pan capacity | | Pan dimensions | Weight | Burner capacity | Electric power | Supply electric power | Power supply line |
|------------------------|--------------|--------|---|--------|-----------------|----------------|-----------------------|-------------------|
| | n° | pas mm | mm | | | | | |
| CLASSIC 6080 SC | 15 18 | 105 | 600x800 | 1400 | 70 | 2 | - | 400/3N~/50 |
| CLASSIC 6080 SE | | 87 | 2x600x400 | 1350 | - | 49+2 | 57+2 | |
| CLASSIC 8095 SC | 15 18 | 105 | 600x990 | 1720 | 81 | 2,5 | - | 400/3N~/50 |
| CLASSIC 8095 SE | | 87 | 800x800 2x(18x26)"/ 660x930 2x(18x30)"/ 760x930 | 1670 | - | 52,5+2,5 | 63+2,5 | |



Pictures, measurements and technical data are non-binding and thus subject to modification with no advance notice.



Ing. POLIN & C. S.p.A.

Viale dell'Industria, 9 - 37135 Verona - Italy - Tel. +39 045 8289111 - Fax + 39 045 8289122 - www.polin.it - polin@polin.it