

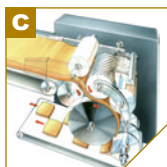

Spezzatrici per ciabatte Spin 300/4

CIABATTE DIVIDER SPIN 300/4

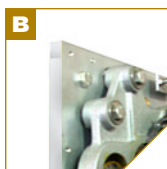

DESCRIZIONE

- larghezza cilindri di laminazione: 300 mm
- struttura costruita interamente in acciaio inox **A**
- struttura della laminazione realizzata con robuste spalle di alluminio dello spessore di 15 mm **B**
- spezzatrice a 4 cilindri con spessore di laminazione variabile (da 6 a 20 mm) **C**
- variazione elettronica della velocità (modelli Kappa e Omega)
- variazione meccanica con variatore della velocità (solo per modello Id).
- capacità nastro di alimentazione: circa 24 kg
- infarinatore sui rulli di laminazione
- dispositivo antintasamento che arresta il nastro di alimentazione per una delicata lavorazione della pasta

DESCRIPTION

- cylinders width: 300 mm
- st/st construction **A**
- sheeting structure made with strong aluminium shoulders, 15 mm thick **B**
- 4 cylinders divider, adjustable sheeting thickness (6-20 mm) **C**
- electronic speed variation for different cutting lengths (only for mod. kappa, omega)
- divider mechanical speed variation (only for mod. Id)
- large capacity feeding belt: 24 kg
- flour sprinkler over the rolling cylinders
- anti-clogging feeler roller for delicate handling of the dough



Caratteristiche tecniche / Technical features

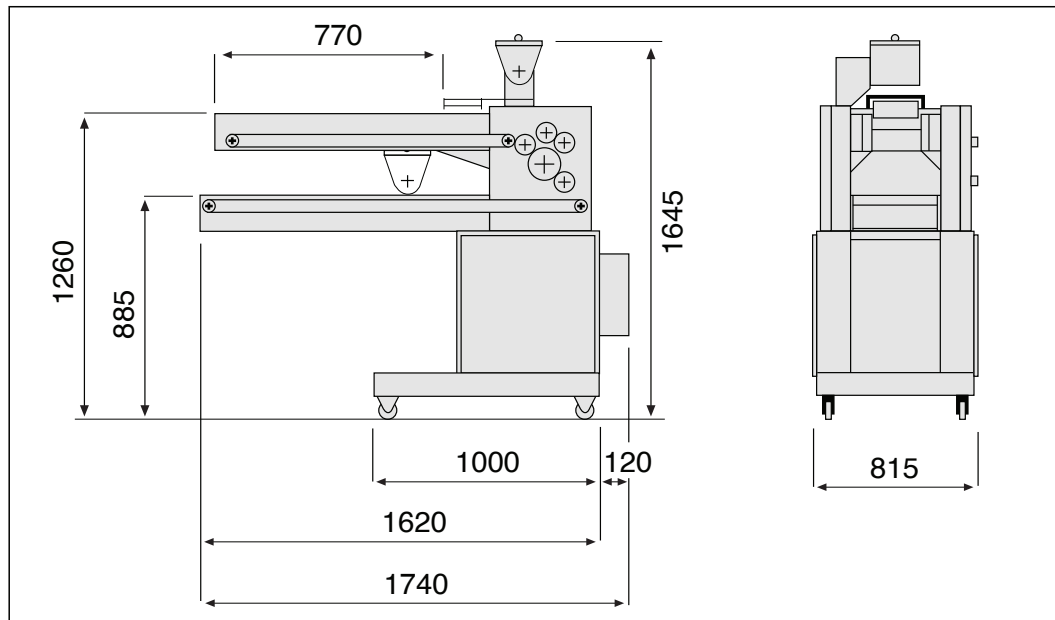

MODELLO	NUMERO FILE COLTELLO	PESO PASTA g	PRODUZIONE pezzi/ora	POTENZA Kw	TENSIONE V/N/Hz	PESO Kg
TYPE	KNIFE: number of rows	WEIGHT DOUGHT g	PRODUCTION pieces/h	POWER Kw	VOLTAGE V/N/Hz	WEIGHT Kg
LD	1	min. 345	1700	0,55	400/3/50	440
		max. 905	900			
LD	2	min. 170	3800	0,55	400/3/50	440
		max. 450	1800			
LD	3	min. 80	5000	0,55	400/3/50	440
		max. 285	2700			
LD	4	min. 65	6000	0,55	400/3/50	440
		max. 120	3500			
LD	5	min. 50	6000	0,55	400/3/50	440
		max. 165	3500			
KAPPA 2 OMEGA	1	min. 270	1700	0,80	400/3/50	470
		max. 1450	900			
KAPPA 2 OMEGA	2	min. 150	3460	0,80	400/3/50	470
		max. 540	1800			
KAPPA 2 OMEGA	3	min. 105	5000	0,80	400/3/50	470
		max. 350	2700			
KAPPA 2 OMEGA	4	min. 90	7000	0,80	400/3/50	470
		max. 270	3500			
KAPPA 2 OMEGA	5	min. 50	7000	0,80	400/3/50	470
		max. 165	3500			

Optional



Coltello a 1 fila
1 row knife

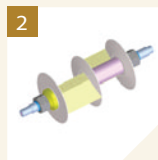

Coltello a 2 file
2 rows knife

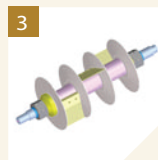

Coltello a 3 file
3 rows knife

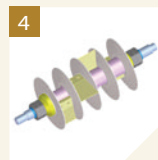

Coltello a 4 file
4 rows knife

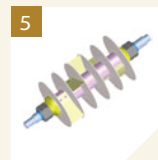

Coltello a 5 file
5 rows knife

Coltelli disponibili fino a 9 file.

Disponibility up to 9 row knife.

I coltelli IN MATERIALE PLASTICO ALIMENTARE a variazione elettronica della velocità per i modelli Kappa e Omega e a variazione meccanica a 3 velocità' per 3 lunghezze di taglio per modello Id.

Easily interchangeable FOOD PLASTIC knives; with electronic speed for model Kappa and Omega; mechanical variation at 3 speeds for 3 different cutting lengths for model Id.

