

The **Compact Series** of depositors are work horses and can be fitted with a full range of Unifiller accessories and attachments.

## COMPACT DEPOSITOR SERIES

Designed by Bakers for Bakers

The Compact is available in four options:

- Compact Table Top FS
- Compact Mobile FS
- Compact Power Lift FS
- Dual (two Compacts on one frame)

### Benefits:

- Small footprint
- Speed and portion accuracy
- Full wash down — all food contact parts dishwasher safe
- Tool free, quick cleaning and change-over design
- Deposit range — 0.3 oz (9 ml) – 18 oz (530 ml)

### Features:

- 5 product cylinder sizes available to meet your production requirements
- Stainless Steel design — Volumetric depositing
- Power Lift Model has a “one touch” system for raising and lowering of hopper
- The Mobile can be height adjusted manually
- Mobile and Power Lift have a 14 US Gallon conical hopper; Table Top has a 6 US Gallon conical hopper

### System includes:

- 2.5” product cylinder
- Removable depositing table
- Spout nozzle and foot pedal
- Quick start guide & spare parts kit

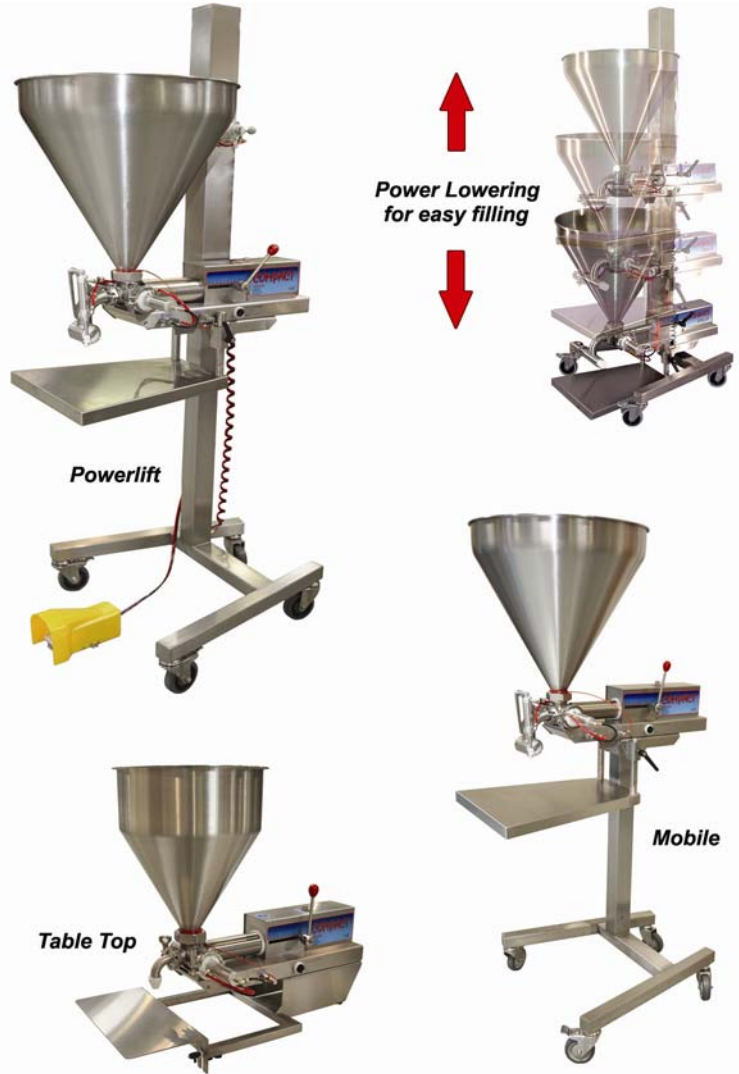

[Click Here to Watch Video](#)



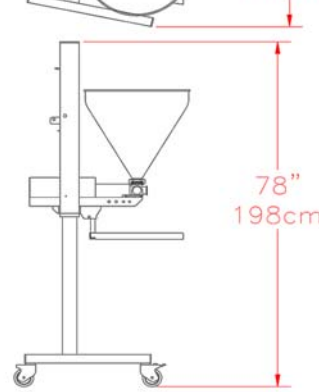
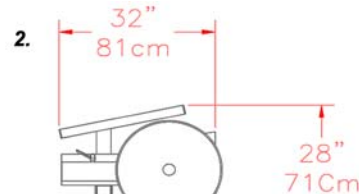
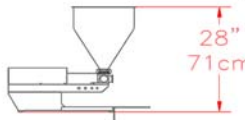
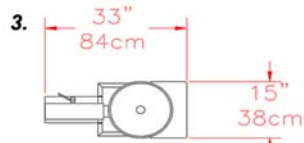
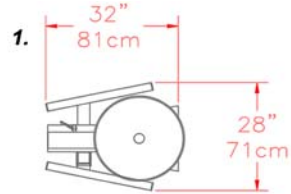





- 1. Compact Mobile
- 2. Compact Powerlift
- 3. Compact Table Top



| Product Cylinder Size | DEPOSIT VOLUME (fl oz) |         |         |          |
|-----------------------|------------------------|---------|---------|----------|
|                       | Min                    |         | Max     |          |
| 3"                    | 1.8 oz                 | (53 ml) | 18 oz   | (530 ml) |
| 2.5"                  | 1.2 oz                 | (35 ml) | 12.3 oz | (360 ml) |
| 2"                    | 0.8 oz                 | (24 ml) | 7.6 oz  | (225 ml) |
| 1.5"                  | 0.5 oz                 | (15 ml) | 4.0 oz  | (120 ml) |
| 1"                    | 0.3 oz                 | (9 ml)  | 1.7 oz  | (50 ml)  |

## Performance Specifications

|  |   |
|--|---|
|  <p><b>Speed</b><br/>Up to 140 deposits/min (8400 deposits/hr) based on deposit size and consistency.</p> |  <p><b>Power</b><br/>3 – 5 CFM @ 80PSI<br/>85-141.5 litres per minute @ 5.5 Bar.</p> |
|  <p><b>Volume</b><br/>0.3 oz to 18 oz.<br/>9ml to 530ml</p>   |  <p><b>Particle Size</b><br/>Up to 3/4" cube<br/>19mm</p>                            |

**Note:** Equipment quoted is designed to run at the quoted speed and is dependent on operator efficiency, skill, and deposit size and product consistency.

## Shipping Information

### Mobile / Power Lift:

- Dimensions: 36" x 30" x 52" (92cm x 76cm x 132cm)
- Weight: 200 lbs. (91kg)

### Table Top:

- Dimensions: 23" x 22" x 26" (58cm x 56cm x 66cm)
- Weight: 85 lbs (39kg)

### Unifiller Systems Inc.

7621 MacDonald Road, Delta, B.C., Canada, V4G 1N3 Phone: (604) 940-2233 Toll-free: (888) 733-8444 Fax: (604) 940-2195

[www.unifiller.com](http://www.unifiller.com) Email: [info@unifiller.com](mailto:info@unifiller.com)