



▶ OVENS LINE

## Pocket 4060 rack oven for bread and pastry



## Compact Pocket oven: quality without compromise!

The Pocket 4060 has been designed to meet the need to combine high-quality production standards with limited space requirements. Furthermore, the assembling is extremely fast and simple.

While maintaining the constructional characteristics and technical standards of Polin rotary ovens, the Pocket trolley ovens are particularly suited for the production of both bread as well as pastry products.

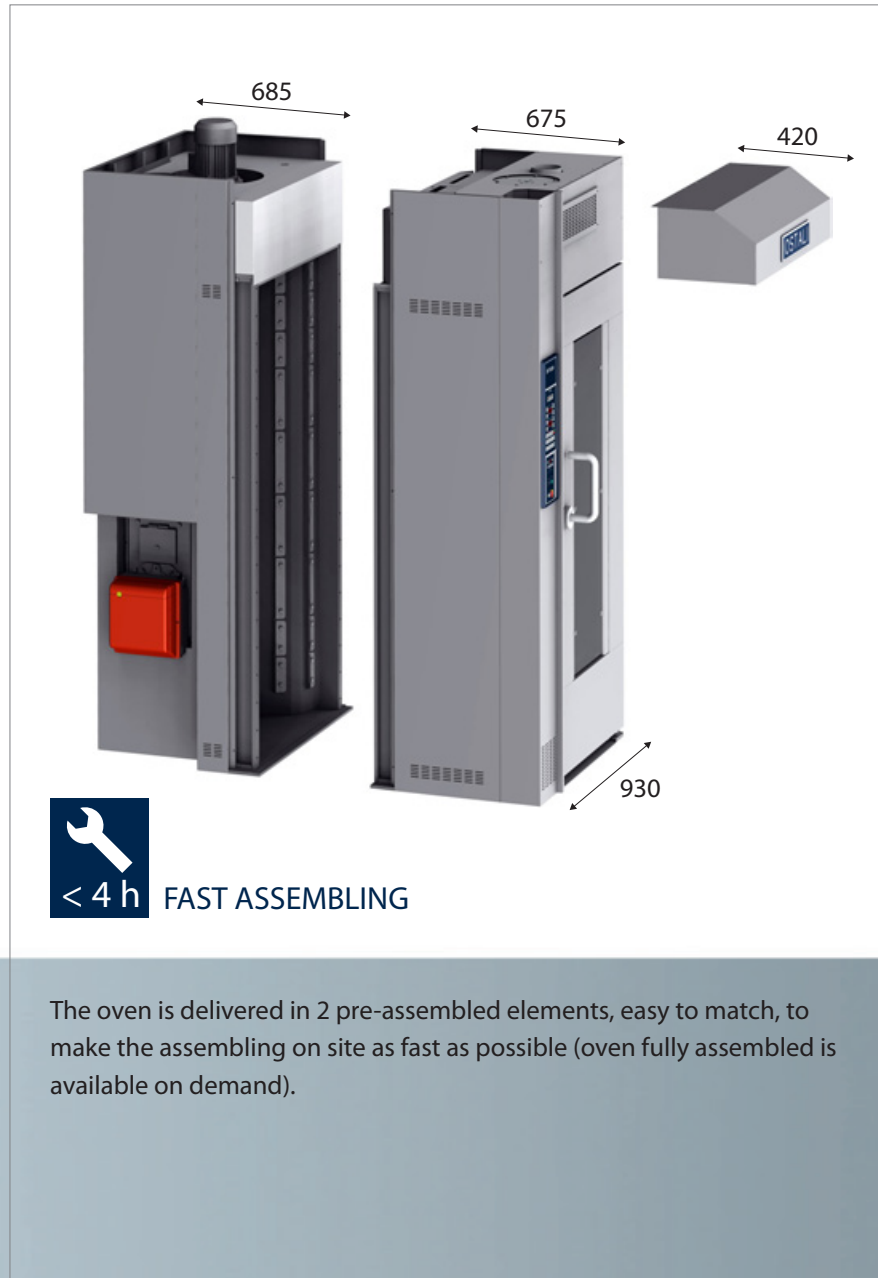

**< 4 h** FAST ASSEMBLING

The oven is delivered in 2 pre-assembled elements, easy to match, to make the assembling on site as fast as possible (oven fully assembled is available on demand).

**FORNO**  
**POCKET**  
4060





## ▶ FEATURES

# The small oven with great standard equipment

The Pocket 4060, in its basic configuration, is equipped with:

- 100 programs digital keyboard
- Stainless steel external coating **1**
- Automatic steam exhausting device for baking chamber
- Door opening at 180° to make rack loading-unloading operations easy in the smallest sites **2**
- Decompression channel
- Thermal insulation made of multiple layers of high density pressed panels.

Large radiant surface and design of the fume circuit

High heat exchange

Operation at lower temperatures

High efficiency

LOW OPERATING CONSUMPTION

Quantity and quality of the utilised materials

**LONG LASTING**

COMBUSTION CHAMBER

## ▶ AIR SYSTEM

# Heat technology

Thanks to the baking chamber volume optimization and to the heat exchanger high efficiency, the oven can be fed with very low power (27.000 kcal/h).

The design of the combustion chamber provides an ample exchange surface, due to the large number of tubes and the special shape of the flue-gas circuit.

This solution, together with the very thick stainless steel refractory structure, allows the oven to obtain remarkable results, such as: high yield, low operating consumption, long service life. **3**



## Automatic steam exhaust device

An automatic valve and an independent duct make the steam exhausting fast. **4**

## Constant pressure baking for even better bread!

Pocket is equipped with an innovative system that keeps the pressure inside the baking chamber constant.

In addition to guaranteeing homogeneity and consistency in daily production, under any environmental condition, this also further improves product quality. **5**

In fact, the flavoured and fragranced steam released by the baking bread is retained and constantly redistributed inside the oven. Independent decompression duct inside the baking chamber to always grant the right pressure.

Large hood to exhaust steam from oven front. **6**

## The perfection of the steamer ball

The steamer has a modular vaporiser unit with cascading elements, equipped with balls (large quantity and high quality of steam). **6**

The balls placed in contact with the water vibrate, crumbling any formation of limestone, with a self-cleaning effect for the elements. **6**



## Automatic steam distribution system

The automatic steam distribution system managed by software, in combination with constant pressure baking, keeps the surface of the product moist for a long period of time.

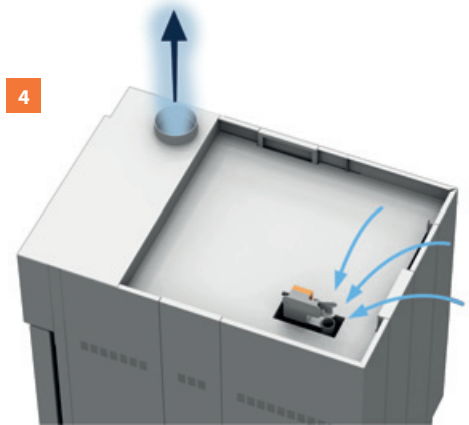

Automatic steam exhaust device

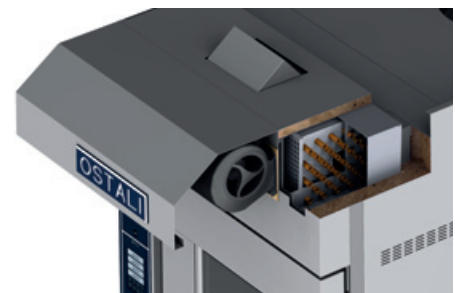

Steam condensing device, wholly integrated in the oven, with exhaust hood, without steam discharge pipes **6**

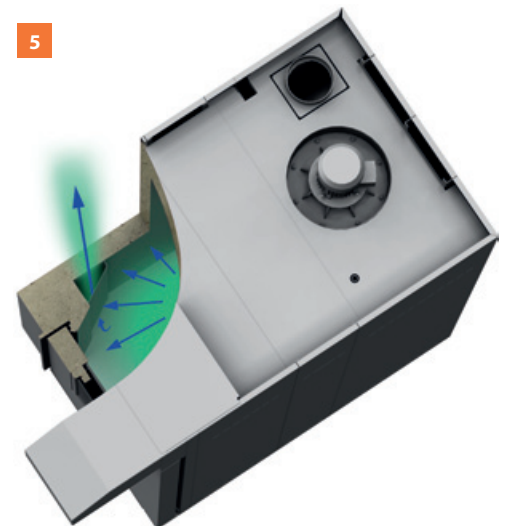

**5**

**6**





## COMPONENTS

### Details that make the difference

Polin ovens are designed with a focus on the details in order to guarantee the best thermal seal, robustness, easy cleaning and long-lasting performance.

The door is equipped with a sturdy outside handle and an emergency handle inside **7**.

Control panel with safety profile **8**

The trolley support hook is entirely cast with a rounded profile and large cross-section **9**

The double-pane window on the door can be opened to facilitate cleaning **10**.

The dual stainless steel/silicon rubber gasket on the vertical walls and top of the door create a perfect thermal seal to ensure a longer service life of the oven **11**.







▶ KEYBOARD

100P



POLIN TOUCH



	Baking programs	100	300
	Phases for each baking cycle	12	10
	Display	LCD 8 rows	TOUCH SCREEN 7"
	Password protected recipes	✓	✓
	Temperature/time limiter	✓	✓
	Automatic system steam distribution	✓	✓
	Daily/weekly automatic start	✓	✓
	Liter meter	⊘	✓
	Exclusive steam exhaust device	✓	✓
	Alarms to display malfunctions	✓	✓
	Key for saving programs	⊘	✓
	Energy saving advanced functions	-	✓
	Baking air speed control	⊘	⊘
	Customizing program for PC-network control of multiple ovens	⊘	⊘
	USB port	⊘	✓

▶ DIMENSIONS

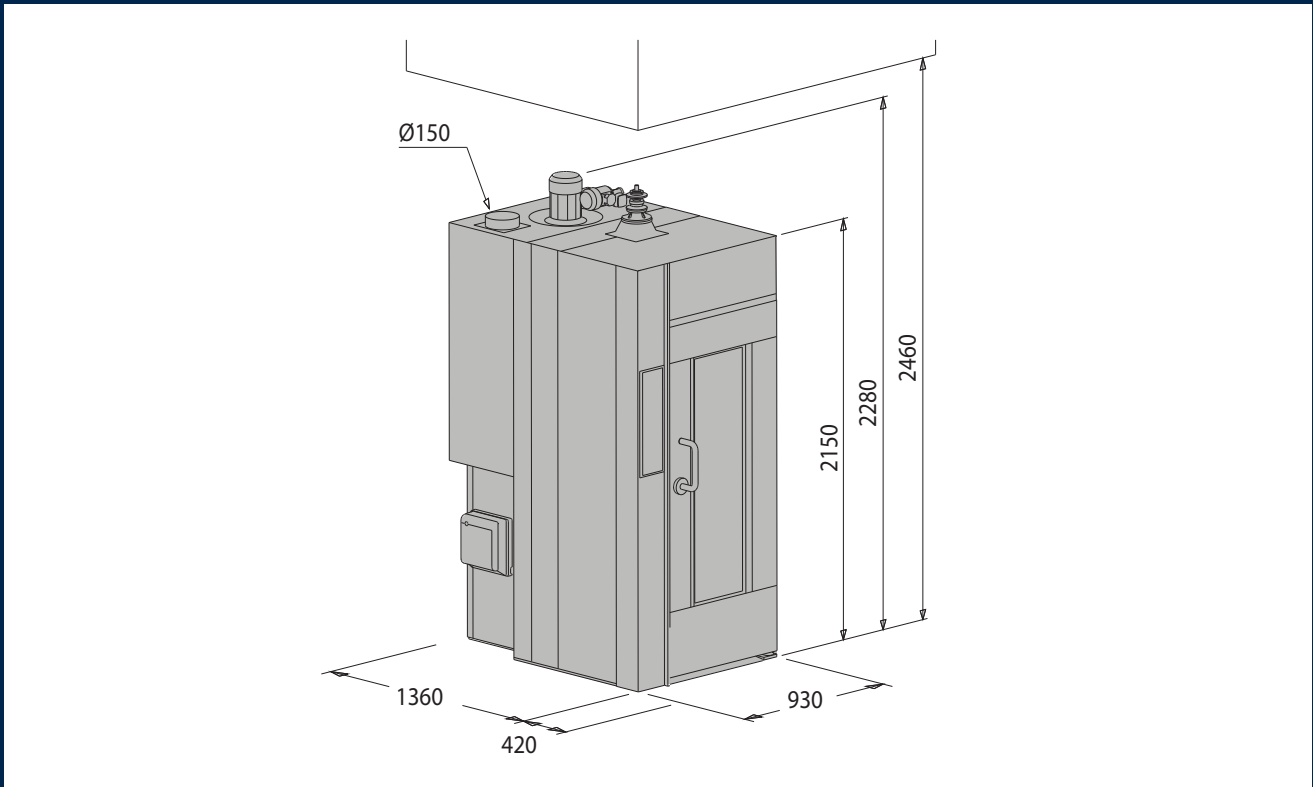

	PAN CAPACITY		PAN DIMENSIONS	MINIMUM DOOR WIDTH	WEIGHT	ELECTRIC POWER	POWER SUPPLY LINE	BURNER CAPACITY	
	n°	pitch	mm	mm	kg	kW		kcal/h	BTU/h
POCKET 4060 PASTRY	15	97	400x600	680	800	20,7+1	400/3N~/50	25.000	99.200
POCKET 4060 BREAD	18	81				27,6+1		27.000	107.100

Pictures, measurements and technical data are non-binding and thus subject to modification with no advance notice.



45 Garema Circuit, Kingsgrove NSW 2208 Australia  
 t. +61 2 9740 5122  
 e. info@rvo.com.au  
 www.rvo.com.au