

Ice a Cake in 1.3 Seconds!

It's a well known fact that icing texture can change from batch to batch. The **Cake-o-Matic 1000i** solves this by automatically adjusting to the changing consistency of your icing. And with the servo control system, you can quickly finish the tops and sides of cakes with a pre-determined amount of icing.

Benefits:

- **ICES UP TO 7 CAKES PER MINUTE**
- Uses standard attachments, and can be fitted with a wide variety of Unifiller decorating attachments
- Ensures consistency and portion control
- Easy to use and operate
- Tool free design — quick cleaning and quick product change-over

Features:

- Fitted with a UNI-1000i base and "swing-away" turntable — doubles as a standard depositor
- Powered work station with servo control system
- Large 14 Gallon (52 Lt) conical hopper
- Stainless steel construction — full wash down design
- Fine height adjustment
- Cake Touch-Up button

System Includes:

- One adjustable turntable to suit 6-8" (150mm -200mm) or 8-12" (200mm-300mm) cakes
- One mid fill nozzle — adjustable 7-12" (177mm -300mm)
- One custom sized top and side icing nozzle
- One 2.5" Product Cylinder
- Foot operated start switch

Cake-O-Matic-1000i

The Only Self Adjusting Cake Icer



1. Batter Deposit

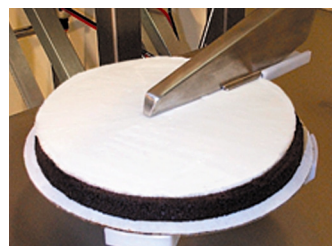

2. Mid Fill Icing



3. Top and Side Icing

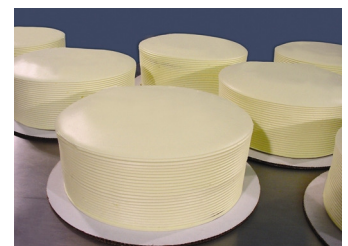

4. Iced Cakes!

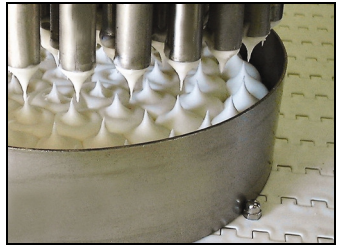
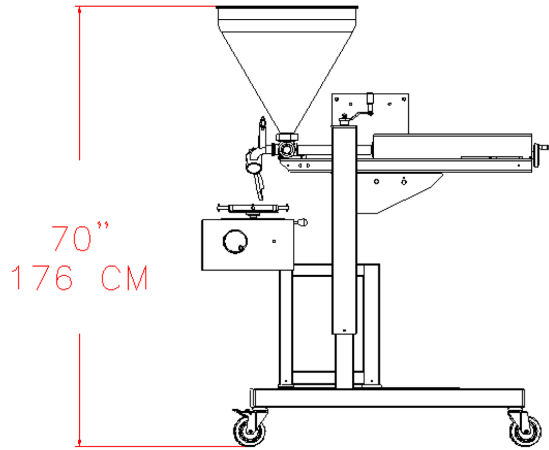
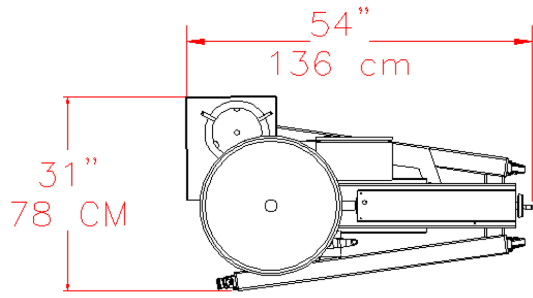
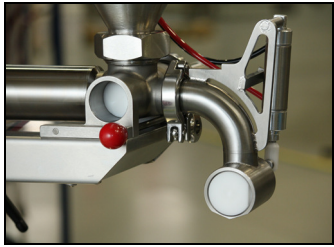
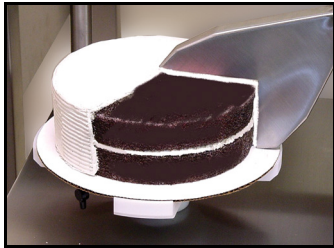

Product Cylinder Size	DEPOSIT VOLUME (fl oz)			
	Min		Max	
3"	3.6 oz	(106 ml)	36 oz	(1064 ml)
2.5"	2.5 oz	(73ml)	24.5 oz	(724 ml)
1.5"	0.8 oz	(24 ml)	8.2 oz	(243 ml)
1"	0.3 oz	(9 ml)	3.3 oz	(98 ml)

Shipping Information

- Dimensions: 59" x 30" x 52" (150cm x 76cm x 132cm)
- Weight: 350 lbs (159 kg)

Performance Specifications:

 <p>Speed Up to 7 cakes per minute when icing cakes Up to 140 deposits/ min (8400 deposits/ hr) based on deposit size and consistency.</p>	 <p>Power Air: 4 CFM @ 80psi 113 liters / minute @5.5 Bar Electrical: 110V AC or 220V AC</p>
 <p>Volume 0.3 to 36 oz 9ml to 1064ml</p>	 <p>Particle Size Up to 3/4" cubic [19mm] soft particulate when used with PC Nozzle (consult your sales rep)</p>

Note: Equipment is designed to run at the quoted speed and is dependent on operator efficiency, skill, and deposit size and product consistency.



45 Garema Circuit, Kingsgrove NSW 2208 Australia
t. +61 2 9740 5122 f. +61 2 9740 5237
e. info@rvo.com.au