

The **Border-Mate** was created to replace the conventional pastry bag with an almost effortless way of piping icings, frostings and decorations onto cakes.

Benefits:

- Dramatically eliminates work related injury such as Carpal Tunnel Syndrome
- No Bags to fill — No Bags to squeeze!
- Allows an entry level operator to automatically produce consistent shell borders quickly
- Full wash down – all food contact parts dishwasher safe
- Tool free, quick cleaning and change-over design

Features:

- Deco-Mate 3 equipped with Border-Mate controls
- Dial in decorations such as shell borders, ribbons and more

System Includes:

- 1 hand bordering nozzle with food grade hose
- Hand nozzle balancer
- 10 gallon (38 liter) hopper and follower plate
- 7 small Standard Bakery Tips and 3 large Standard Bakery Tips
- Spare parts kit

Border-Mate

Automated Shell Border Decoration!





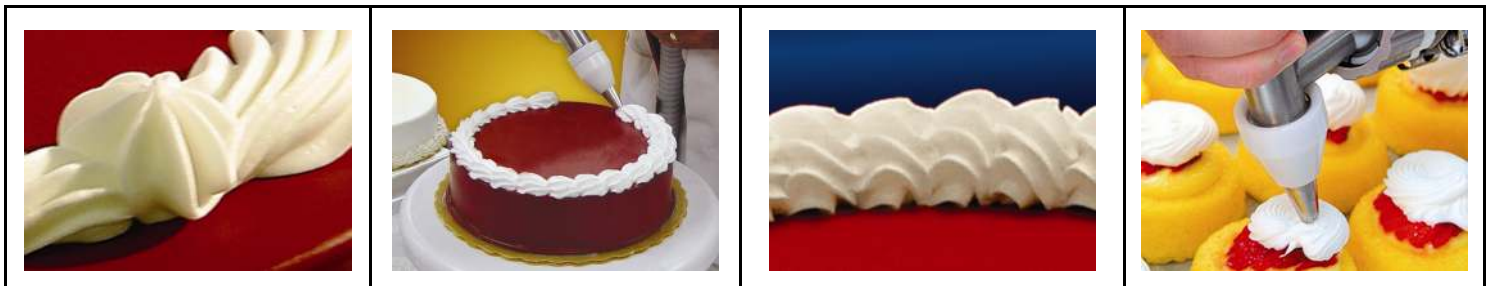

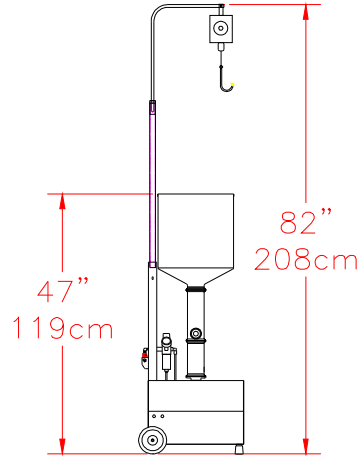
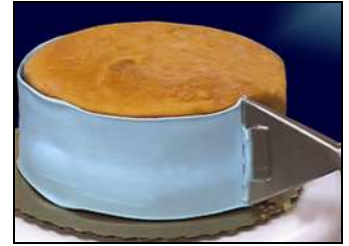
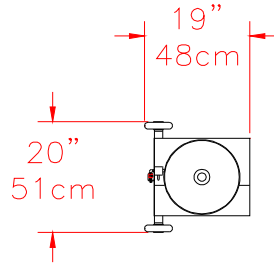
Easy to use controls





Performance Specifications:

 <p>Speed Operator Controlled</p>	 <p>Power Air only 4 CFM@ 20-80 PSI 113 liters/minute @ 1.3-5.5 Bar</p>
 <p>Volume Up to 17fl. oz./stroke Up to 502ml/stroke</p>	 <p>Particulate Size Smooth products only (no particulate)</p>

Shipping Information

- Dimensions: 21"x 21"x 38" (53cm x 53cm x 97cm)
- Weight: 90 lbs (41kg)

Note: Equipment quoted is designed to run at the quoted speed and is dependent on operator efficiency, skill, and deposit size and product consistency.

Unifiller Systems Inc. North America

Head Office Canada
Phone: (604) 940-2233
Email: info@unifiller.com
Website: www.unifiller.com

Unifiller Systems UK Ltd.

United Kingdom
Phone: 01604 499846
Email: uk@unifiller.com
Website: www.unifiller.com

Unifiller Systems Europe GmbH

Germany
Phone: +49 7621 583 6310
Email: info@unifiller-europe.com
Website: www.unifiller-europe.com